



User Interface V5.1 for PL7 DOS

Sections	Page
1 Presentation	
1.1 Introduction	1/2
1.2 Ease of Use	1/3
1.3 Compatible PLCs	1/4
2 Installation	
2.1 Requirements for Installation	2/2
2.2 User Interface Installation Procedure	2/4
2.3 TSX L Software Installation Procedure	2/6
3 User Interface	
3.1 Window Presentation	3/2
3.2 Dialog Box Presentation	3/5
3.3 Keyboard	3/6
3.4 Help	3/6
4 Using the User Interface	
4.1 Primary Window	4/3
4.2 File Menu	4/8
4.3 Communication Menu	4/22
4.4 Keymgr Menu	4/25
4.5 Accessing a TXT L Program	4/26
5 Key Manager Function	
5.1 Presentation	5/2
5.2 Functions	5/4
5.3 Accessing the Key Manager	5/7
5.4 Action Menu	5/9
5.5 Key Module Markings	5/19

Sections	Page
6 PROM Programmer	
6.1 Using the PROM Programmer	6/2
6.2 Selecting the Serial Port	6/4
6.3 Using the funcTion Menu	6/5
6.4 Using the File Menu	6/6
6.5 Selecting funcTion	6/7
7 Appendix	
7.1 Program Storage Tree Layout in the User Interface	7/2
7.2 Application File Organization	7/3
7.3 Application Migration from PL7-1/2 V3 to V5	7/4
7.4 PL7-2 Application Migration in the Software Workshop	7/5
7.5 Installing a Utility Program	7/6
7.6 Telemecanique Help	7/9
7.7 List of Help Topics	7/10
7.8 RAM Requirements	7/11
7.9 Installing a PL7-3 V3 Program	7/11
7.10 Glossary	7/13
7.11 Forcing User Interface Parameters	7/14



Sub-Sections		Page
1.1	Introduction	1/2
1.2	Ease of Use	1/3
1.3	Compatible PLCs	1/4

1.1 Introduction

The Telemecanique User Interface supports the creation of single PLC applications. It runs under DOS versions 4.0 and 5.0 and DR-DOS 5.0.

It provides program integrator functions, provides services and manages the completed application.

It lets the user access application design programs for the following PLCs:

- TSX17-10/20 (PL7-1 language version V5),
- TSX17-20, TSX27/47 (PL7-2 language version V5),
- TSXV3 (PL7-3 language, version V3 only),

and the TSX Series 7 PLC diagnostics program: SYSDIAG.

1.2 Ease of Use

When the User Interface is invoked, the primary window allows access to the various programs. Only one programming function among those installed in the user interface can be accessed for a given type of PLC.

User Interface Primary Window

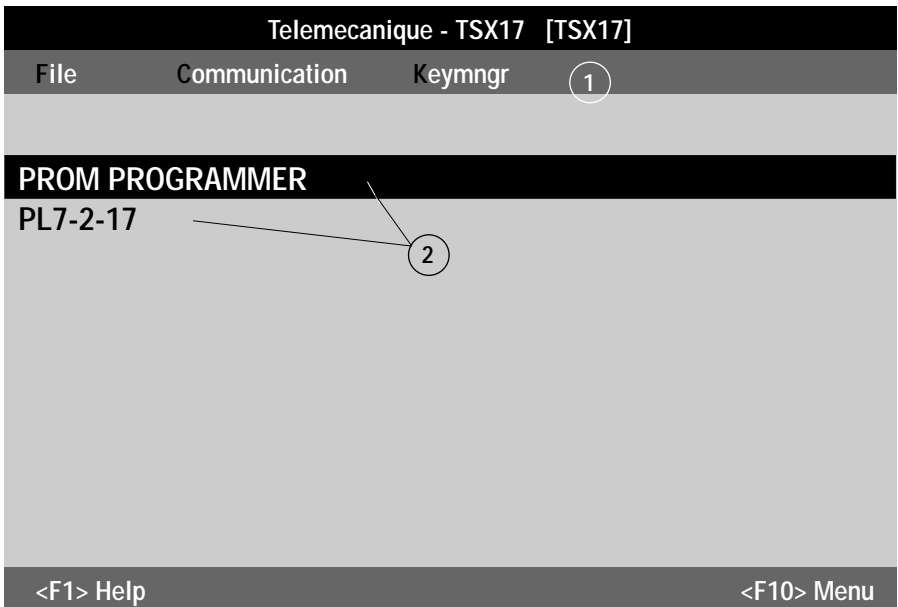

1 - Menus

2 - Functions

- PROM Programmer for storing programs in EPROM/EEPROM user memory cartridges,
- PL7-2-17 programming software.

The User Interface also lets the user access other utilities programs (refer to the Appendix).

Note:

Version V3 level programs are recognized and can be accessed directly by the User Interface (and they are named PL7-xV3).

1.3 Compatible PLCs

TSX Series 7 PLCs that can be accessed for programming and adjustment using the User Interface are listed below:

- **TSX17-1**

TSX 17-10/20 Micro-PLCs that support PL7-1.

- **TSX17**

TSX 17-20 PLCs that are programmed using PL7-2.

- **TSX27/47**

TSX Series 7 sequential PLCs that are programmed using PL7-2.

Compatible PLCs include:

- TSX 27,
- TSX 47-10, 47-20 and 47-J.

- **TSXV3**

Multi-functions version V2 and V3 PLCs that are programmed using PL7-3 and including:

- TSX 47-3, TSX 47-31,
- TSX 67-20, TSX 67-21 and TSX 67-30,
- TSX 87-10, TSX 87-20, TSX 87-30 and TSX 87-31.

The following TSX Series PLCs can also be accessed via the User Interface, but in Adjust mode only:

- **TSXV4 / PMXV4**

- TSX 47-40 to TSX 107-40,
- PMX 47-40 to PMX 107-40,

- **TSXV5 / PMXV5**

- TSX 47-40 to TSX 107-40,
- PMX 47-40 to PMX 107-40,



ONLY ONE APPLICATION CAN BE ACCESSED AT ONE TIME. Always ensure that applications developed are backed-up on hard disk or diskette.



Sub-Sections		Page
2.1	Requirements for Installation	<i>2/2</i>
2.2	User Interface Installation Procedure	<i>2/4</i>
2.3	TSX L Software Installation Procedure	<i>2/6</i>

2.1 Requirements for Installation

In order to use the User Interface system the following components are required:

- The User Interface software package comprising:
 - A 3 1/2" diskette - Ref. TSX LF USR V5E.
- One of the configurations listed below:
 - An FTX 417 terminal,
 - An FTX 507 terminal,
 - A PC compatible microcomputer.

These configurations with at least an **80286** microprocessor must comprise:

- 1 Mbyte of RAM (**580 Kbytes min.**),
- A hard disk (40 Mbytes recommended),
- An EGA or VGA monitor (monochrome or color),
- The appropriate national or international keyboard,
- MS-DOS 4.0 or higher Operating System. Some Telemecanique terminal systems have DR-DOS 5.0 pre-installed and ready to use.



Despite the efforts made to ensure compatibility, Telemecanique cannot guarantee that these programs will run on all PC compatible microcomputers available, even if they meet all of the requirements listed above.

The following choices are available to the user when installing the User Interface:

- Language (from the five available),
- Installation procedure: Automatic or Custom mode.

When an **Automatic Mode** installation is selected, all of the parameters are set to their default values. The program will be installed on Disk C and the "CONFIG.SYS" and "AUTOEXEC.BAT" files are updated. The previous versions of these files are retained as "CONFIG.USR" and "AUTOEXEC.USR".

The software installation procedure will replace client files with Telemecanique files. Before replacement, client files are analyzed so that operating parameters will be saved.

Before starting the installation procedure, ensure that the following parameters are correctly filled-in:

- COUNTRY and SHELL for CONFIG.SYS,
- PATH, KEYBOARD and SET COMSPEC for AUTOEXEC.BAT.

If any of these parameters are missing, their default values are:

- COUNTRY = 001, 437, C:\DOS\COUNTRY.SYS,
- SHELL=\DOS\COMMAND.COM/P/E:512,
- PATH C:\; C:\DOS,
- KEYB US,
- SET COMSPEC=C:\DOS\COMMAND.COM.

When the terminal is restarted, the command:

- C:\TE_BOOT PRE causes the system to restart using the previous versions of the AUTOEXEC.BAT and COMMAND.SYS files,
- C:\TE_BOOT TE causes the system to restart using the Telemecanique AUTOEXEC.BAT and COMMAND.COM files.

When a **Custom Mode** installation is selected, the values of the parameters that can be modified are left up to the user to enter and who retains control over all phases of the installation procedure.

Once User Interface installation is complete, the terminal must be initialized to validate the changes made to the CONFIG.SYS and AUTOEXEC.BAT files (refer to the Appendix, Sub-section 7.9).

If the user selected "Automatic" start-up mode, the user must quit the User Interface by selecting **File eXit Ok**, to return to DOS for installation of other programs that run in the User Interface environment.



Remark:

Using SUBST and JOIN commands in the AUTOEXEC.BAT FILE IS NOT RECOMMENDED for installing the User Interface.

Using IF to extend or modify the PATH variable in the AUTOEXEC.BAT FILE IS NOT RECOMMENDED EITHER.

2.2 User Interface Installation Procedure

Insert the "User Interface" diskette into the drive and type:

A: or B: (depending on the diskette drive used).

- Then type: Install , the installation screen will be displayed, leaving the user to confirm the installation procedure by pressing .

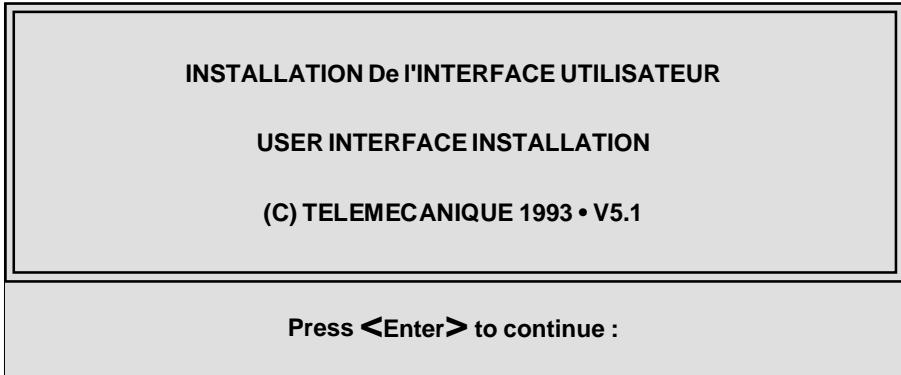

- Select the language for installation messages: for example for "English" select 2 then confirm by pressing .
- Specify the language to use for displaying messages 2 (selects English).
- Now select the installation mode.

Example: Automatic mode

The system will use drive C: and create the XDOSSYS directory to which all User Interface files will be copied.

Once the files have been copied, the system will prompt the user to make the Start-Up mode selection.

Two modes can be selected:

- **Automatic Mode:** Runs the User Interface as soon as the terminal is powered-up or restarted,
- **Manual Mode:** Runs the User Interface after the user enters the TE command.

START-UP SELECTION...

The installation procedure lets you select the start-up mode for the User Interface.

Automatic Mode: Selects the interface on power-up or after restart,
Manual Mode : Selects the interface with the TE command.

1 - AUTOMATIC

2 - MANUAL

Your choice : 2



Remark:

Mode selection is made by typing 1 for automatic mode or 2 for manual mode.

The user is prompted to perform a configuration check.

The installation of the User Interface is now complete.

Initialize the terminal by pressing CTRL, ALT, DEL.

It is now possible to install programs in the User Interface environment.



Note:

The **PROM PROGRAMMER** function is **installed directly** as soon as the User Interface is loaded.

2.3 TSX L Software Installation Procedure

Installation description:

- From the DOS prompt, for example C:\.
- Insert the PL7 diskette into the appropriate diskette drive.
- Type the command A:\ (or B:\) (depending on the selected drive).
- Confirm the selection by pressing .
- Type **INSTALL** followed by , the **installation window** will be displayed:



- After pressing , the PL7 language files are copied to the \XDOSSYS\ directory created when the User Interface was installed. The following information is displayed:

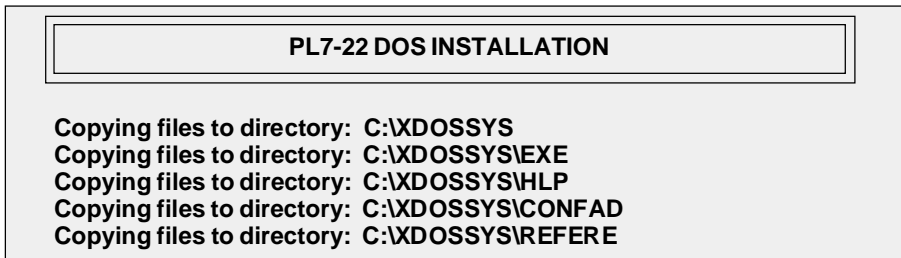

Note:

Do not use the DOS Shell from the User Interface to install the program.

- Once all of the files have been copied, the user is prompted to run a configuration check. The check ensures the coherence of the programs installed in the User Interface.

CONFIGURATION CHECK...

The installation procedure can perform a check on the program configuration of the Telemecanique Software installed.

If you have just completed the last program installation required before starting, you can run a complete check on the program configuration. If not, run the complete check once you have installed all software.

- 1 Last installation completed, run configuration check.
- 2 Run check later, other programs still waiting to be installed.

- Pressing starts the configuration check and displays the Installation Complete screen.

INSTALLATION COMPLETE...

The installation procedure is complete.

PL7 22 DOS is now installed on your system.

Press <Enter>

Ensure that at least 570/580 Kbytes of memory remains available (using the MEM command), refer to the Appendix, Sub-section 7.8.



Sub-Sections		Page
3.1	Window Presentation	3/2
	3.1-1 Primary Window	3/2
	3.1-2 Action Bar	3/3
	3.1-3 Command List	3/4
3.2	Dialog Box Presentation	3/5
3.3	Keyboard	3/6
3.4	Help	3/6

3.1 Window Presentation

3.1-1 Primary Window

As soon as the User Interface is invoked, the following window is opened on-screen:



The **list** details the **programs** available for the PLC station used. Any program installed can be invoked directly and is shown in this list without any need to declare it specially (refer to the Appendix, Sub-section 7.5).

3.1-2 Action Bar

The action bar displays the commands that can be accessed.

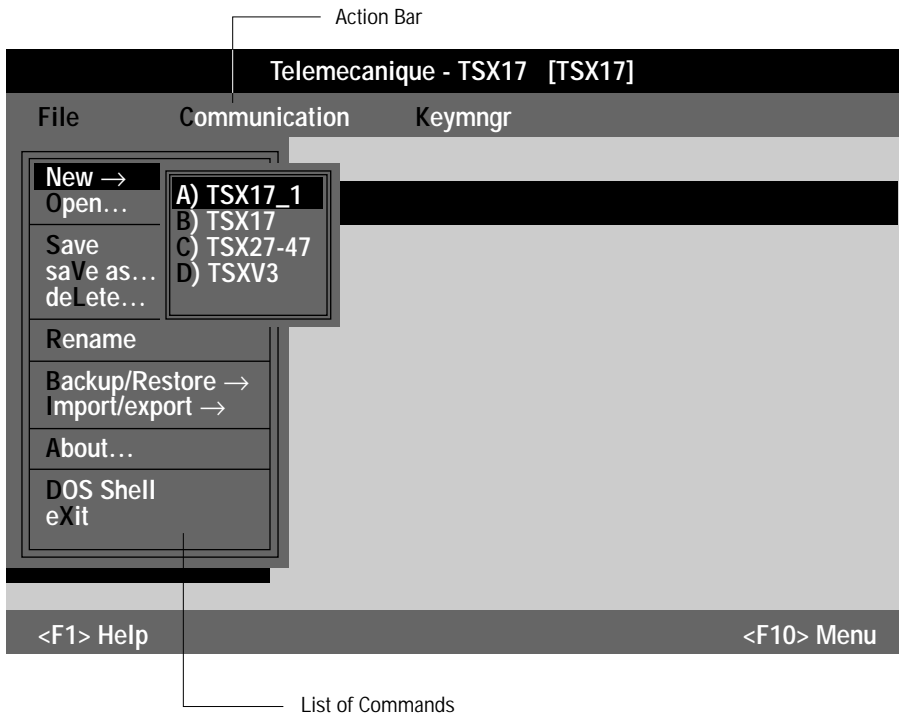

These commands are selected from the keyboard:

- Using the keyboard shortcut (command letter that is shown as a black capital letter),
- Using the **↑** **↓** cursor keys and pressing **↵** to confirm.

Example: **Open** : keyboard shortcut **O**.

3.1-3 Command List

A horizontal arrow pointing right shows that there is a sub-menu that can be accessed.

Example: Backup/Restore→

On-screen this looks like:

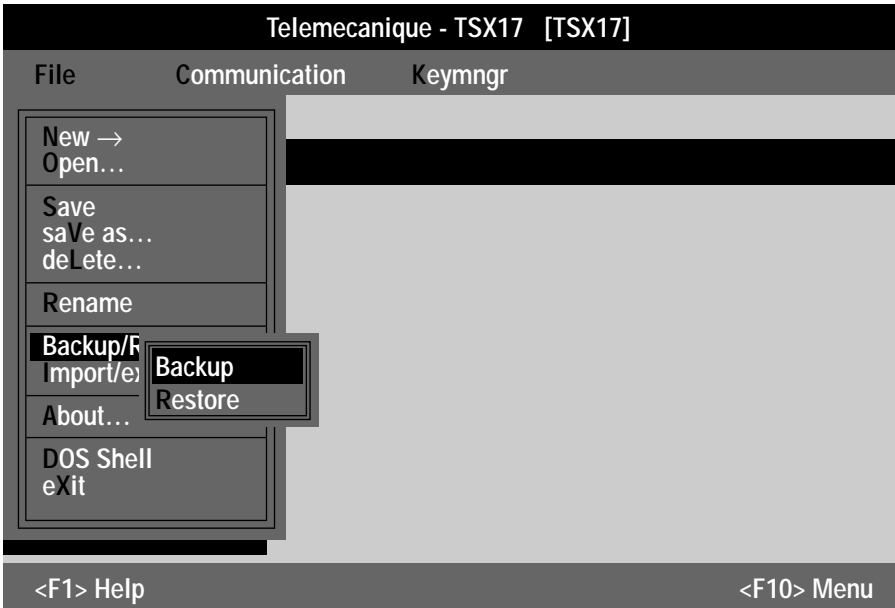

The sub-menu now lets the user access Backup or Restore commands for Archive files.



Note:

The presence of " ... " after a command indicates access to a dialog box.

3.2 Dialog Box Presentation

Some User Interface commands require that the user enter additional information in order to complete the required action.

The dialog box is a full-screen one and is shown below:

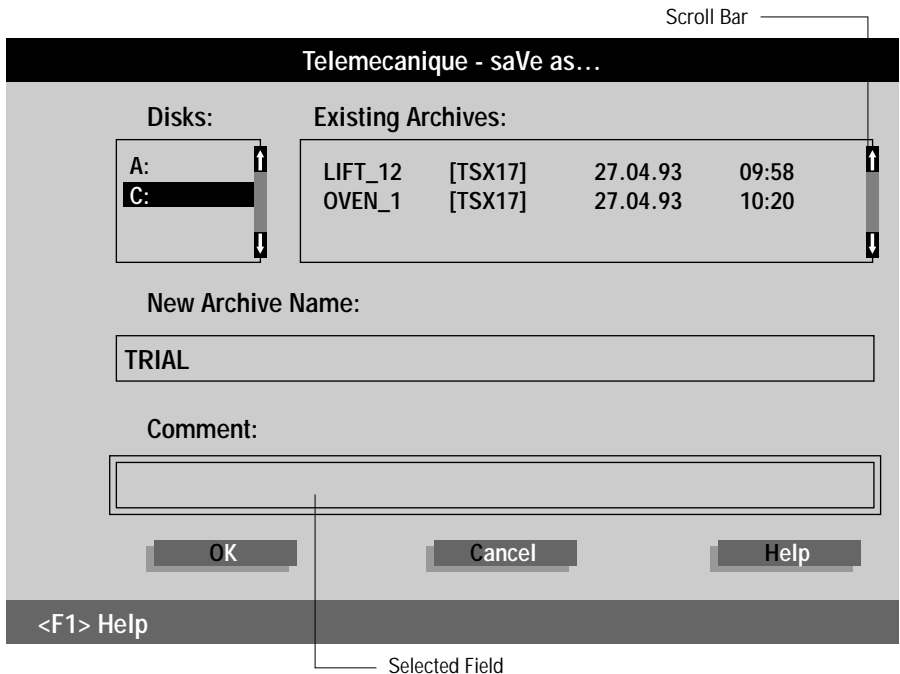

Like a window, the dialog box:

- Has a **Title** that specifies the command,
- Lets the user access a **Help** screen that is called-up by pressing <F1>.

The dialog box comprises **selection fields** depending on the type of command and one or more **data entry fields**.

Across the bottom of the dialog box, **three buttons** let the user confirm or cancel an action.

The dialog box also has scroll bars, so that the user can see all of the information displayed in the various fields.

Using the dialog box:

Pressing the (↑) (↓) cursor keys lets the user move around the screen and select the required information from the appropriate field.

Pressing the (→) or (TAB) keys moves the selection to the next screen.

The user can access the buttons by pressing (TAB).

The (←) (→) cursor keys let the user select a button and pressing (↵) confirms the selection made, invoking the command.

Command (↵) directly validates the dialog box entries.

3.3 Keyboard





All commands are executed from the keyboard. The various commands can be invoked using the:



- Function keys,
- Cursor keys,
- Keyboard shortcuts.

The function keys used are <F1> and <F10>.

F1: Calls-up the context related Help screen (refer to the Appendix, Sub-section 7.7).
Pressing <F1> lets the user access the Telemecanique help screen.

F10: Lets the user access the action bar (menu line).

The cursor is moved on-screen using the     cursor keys.

The  or  keys let the user move between fields within the dialog box.

The  key lets the user cancel the current command.

The  key confirms the current command or action.

The keyboard shortcuts are shown on-screen by the command letter in black capitals.

Example: Confirm (OK) **O** (keyboard shortcut).

3.4 Help

When the user presses <F1>, the context related help screen is displayed. The user can move within the help screen using the , , , ,   keys.

The Action bar displays three headings:

- Files: eXit (returns the user to the User Interface),
- Categories: Lists the Help topics,
- Help = <F1>: Describes the on-line help commands.

The user can exit the Help screen by pressing:

- <F10> File eXit
- or **X**
- or .



Sub-Sections	Page
4.1 Primary Window	4/3
4.1-1 Title	4/3
4.1-2 Action Bar	4/4
4.1-3 Selection Bar	4/4
4.1-4 Accessing an Application	4/4
4.1-5 Archive Field	4/5
4.1-6 Backup/Restore the Current Application	4/5
4.1-7 User Interface Commands	4/6
4.2 File Menu	4/8
4.2-1 New Command	4/9
4.2-2 Open Command	4/10
4.2-3 Save Command	4/11
4.2-4 Save As Command	4/12
4.2-5 Delete Command	4/13
4.2-6 Rename Command	4/14
4.2-7 Backup Command	4/15
4.2-8 Restore Command	4/16
4.2-9 Import Command	4/17
4.2-10 Export Command	4/19
4.2-11 About Command	4/20
4.2-12 DOS Shell Command	4/20
4.2-13 Exit Command	4/21
4.3 Communication Menu	4/22
4.3-1 Address Command	4/22
4.3-2 Drivers	4/24
4.4 Keymgr Menu	4/25

4.5	Accessing a TSX L Program	4/26
	4.5-1 Purpose	4/26
	4.5-2 Path Description	4/26

4.1 Primary Window

When the terminal is powered-up or when the command TE is entered, the following screen is displayed:

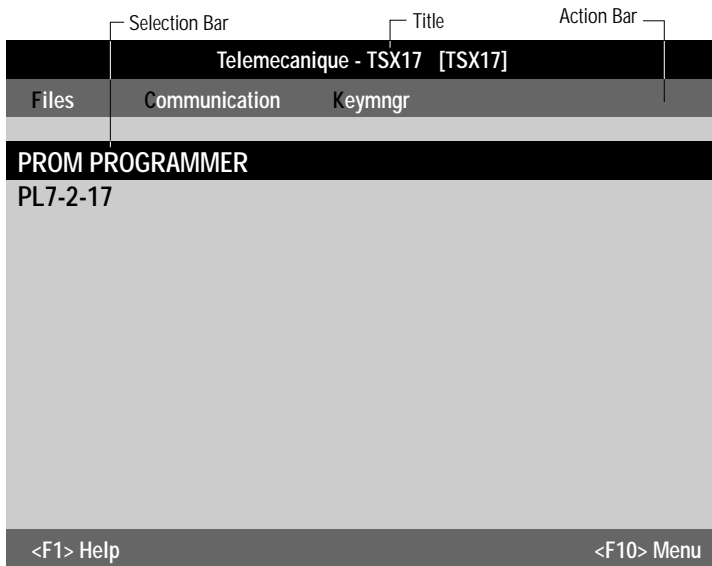

This screen displays a Title, an Action Bar and a Selection Bar that shows which program is selected.

4.1-1 Title

Identifies the station name and type (identical names are used by default).

Telemecanique<Station Name>[<Station Type>]

After selecting "New", the station name is that of the selected station type. The "Rename" command lets the user change this name.

4.1-2 Action Bar

Comprises all of the menu titles that apply to a station.

The menus accessed from the action bar are all pull-down menus.

4.1-3 Selection Bar

Lets the user make selections from the functions available in the User Interface. The selected function is highlighted in reverse video, pressing the  key will invoke the corresponding program.

4.1-4 Accessing an Application

The User Interface controls a single automation application for a single PLC. This is the current application in the work field. All of the execution commands and archive management functions apply to this application.



Important:

Reloading the work field with another application will overwrite the current application.



The "File" menu lets the user save the current application before reloading the work field.

4.1-5 Archive Field

The User Interface supports an **Archive** field in parallel with the Work field, letting the user save the various versions of a given application or applications for other PLCs. The management commands for this function are located in the "Files" menu.

Principle of Access to Fields

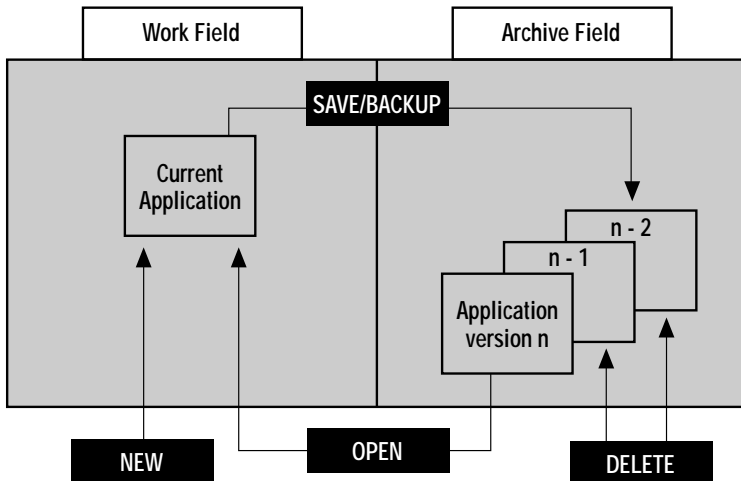

The commands shown on a black background are taken from the File menu.

4.1-6 Backup/Restore the Current Application

The "Backup" and "Restore" commands support application transfers between devices that use the User Interface (hard disk, diskette) and respect the file storage tree layout.

Note

If a non-standard storage tree layout is used on the disk, it is possible to access the various application files via the Import-Export commands used to perform application file transfer from V3 to V5 level.

4.1-7 User Interface Commands

Two types of commands are available:

- Program invocation commands,
- Commands accessible by pull-down menu.

• Program Invocation

The initial screen displays all of the tools and functions that are available for the type of PLC used in the current application.

To select a tool or function from the list, move the selection bar using the \downarrow \uparrow cursor keys, then press \leftarrow to confirm the selection made.

Note: The Key Manager (Keymgr) that can be accessed from the action bar is not linked to a specific type of PLC, but lets the user manage the rights of use for the various Telemecanique programs.

• Menu commands

Commands are accessed by selecting the appropriate menu from the action bar, then moving the selection bar down the pull-down menu list using the \downarrow \uparrow keys.

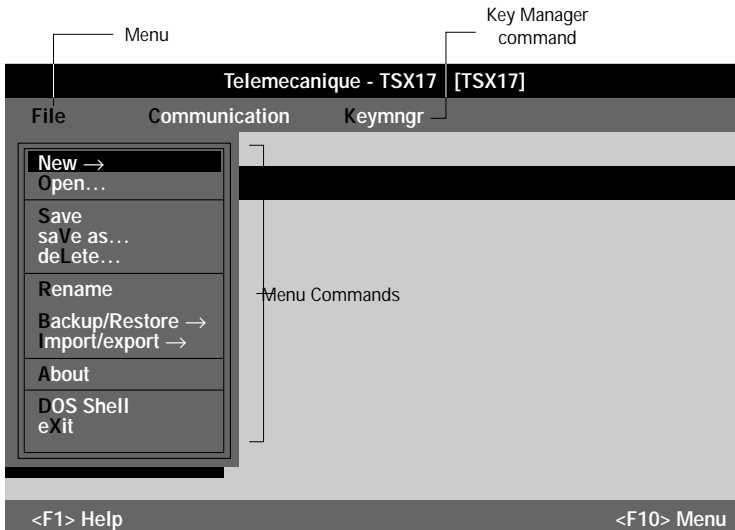

- **Keyboard shortcuts**

To access a Menu command using the keyboard shortcut, type the letter corresponding to the one displayed in reverse video in the menu command word.

Example:

for **File** type **F**

The functions of the <F1> and <F10> keys are shown at the bottom of the screen.

F1 : Access to on-line help,

F10 : Access to the first item in the action bar.

4.2 File Menu

The File pull-down menu offers 11 commands supporting actions for managing PLCs and their automation applications.

This menu is shown below:



The various commands are commented on the following pages.

When these commands are executed, a dialog box may be displayed with the following options:

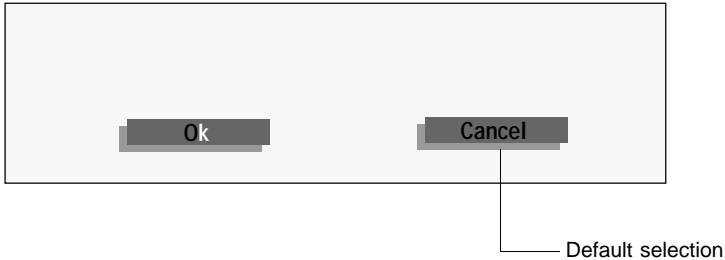

Ok Confirms the command



Cancel Cancels the command

4.2-1 New Command

This command lets the user access TSX Series 7 PLC selection (1). Once the selection is confirmed, the User Interface initializes the work field so that a new application can be created.

**Note:**

A dialog box lets the user abort this function, if necessary, to avoid overwriting the current application.

The next window is displayed once the New command (keyboard shortcut **N**) is selected and the PLC is selected by keyboard shortcut or by pressing   followed by **<Enter>**.

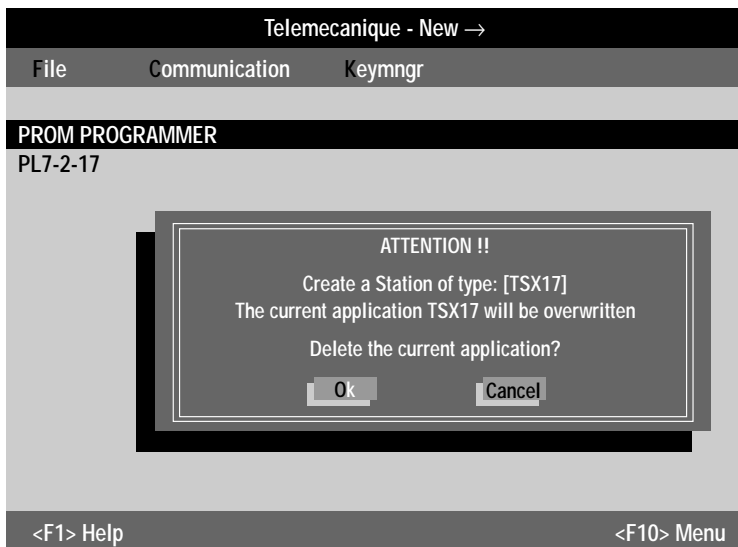

(1) Using SYSDIAG, other device types are proposed, such as NUM, XBT, etc.

4.2-2 Open Command

This command loads an application stored in the storage field (on disk or diskette) to the work field.

This function is accessed by typing **O** in the Open command.

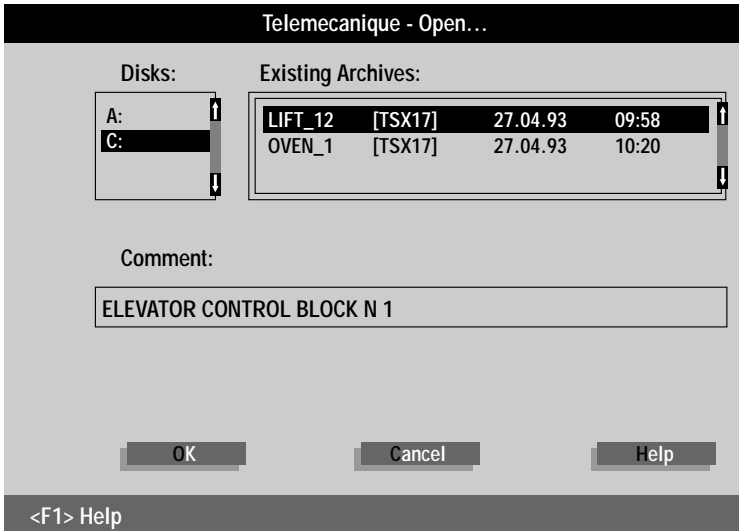

- Select the drive: use to move within the "Disks" field.
- Select the saved application: use to move within the "Existing Archives" field.

lets the user move between the fields.

lets the user access the command buttons.



4.2-3 Save Command

This command saves the current application, present in the work field, in the archive storage field. The saved copy will have the same name as the original.

Press **S** in the Save command.

Note:

A dialog box warns the user that the previously saved project with the same name will be overwritten with the new one!

Selecting **Ok** confirms saving of the application in the archive storage field.



4.2-4 Save As Command

This command lets the user save the current application under a new name in the archive storage field.

This command is selected by typing **V** in the saVe as... command. The following screen is displayed:

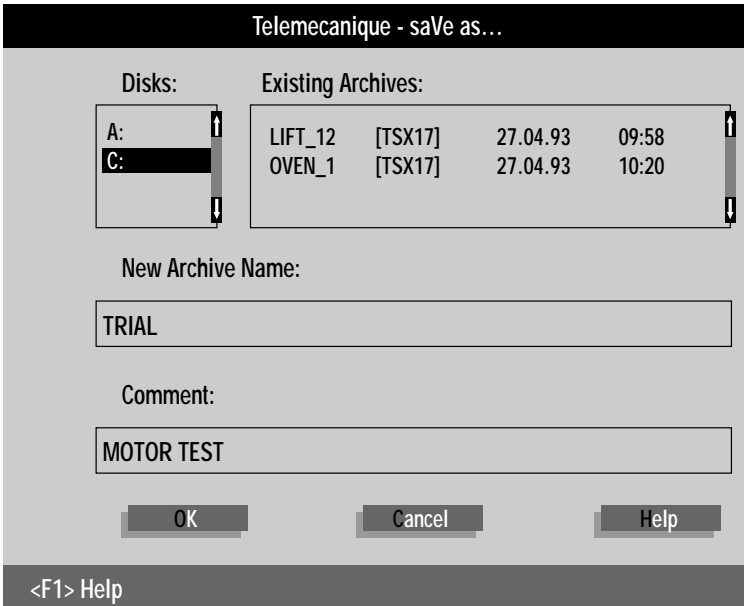

Note:

The window lets the user enter a comment of up to 50 characters max. to specify the version level of the application saved or the type of application.

This type of command lets the user save various applications in the archive storage field.

4.2-5 Delete Command

This command deletes the application whose name is displayed in reverse video in the window, from the archive storage field.

This command is selected by typing **L** in the deLete command. The following screen is displayed:

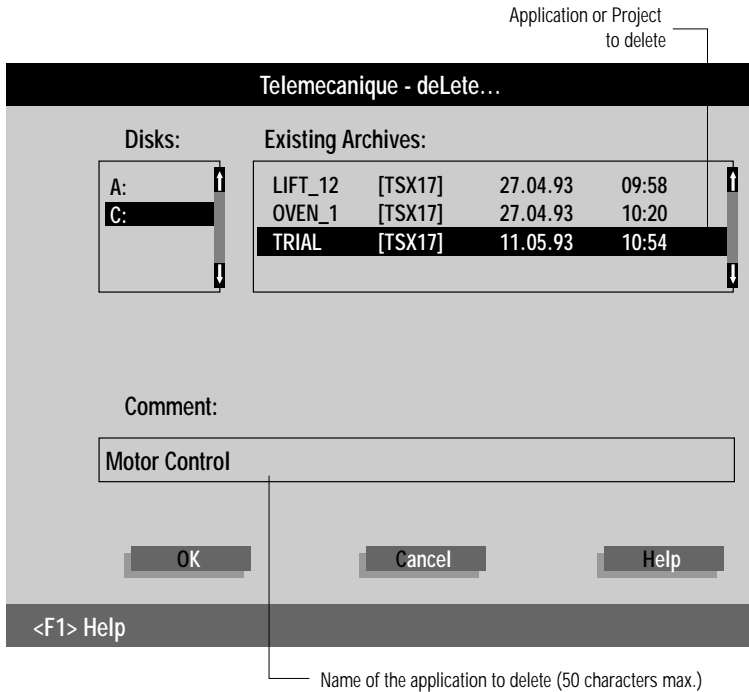

When the command is confirmed, a message warns the user that the action can be aborted, if necessary by selecting Cancel.



4.2-6 Rename Command

This command lets the user change the current project and/or station name.

This command is accessed by typing **R** in the Rename command. The following screen is displayed:

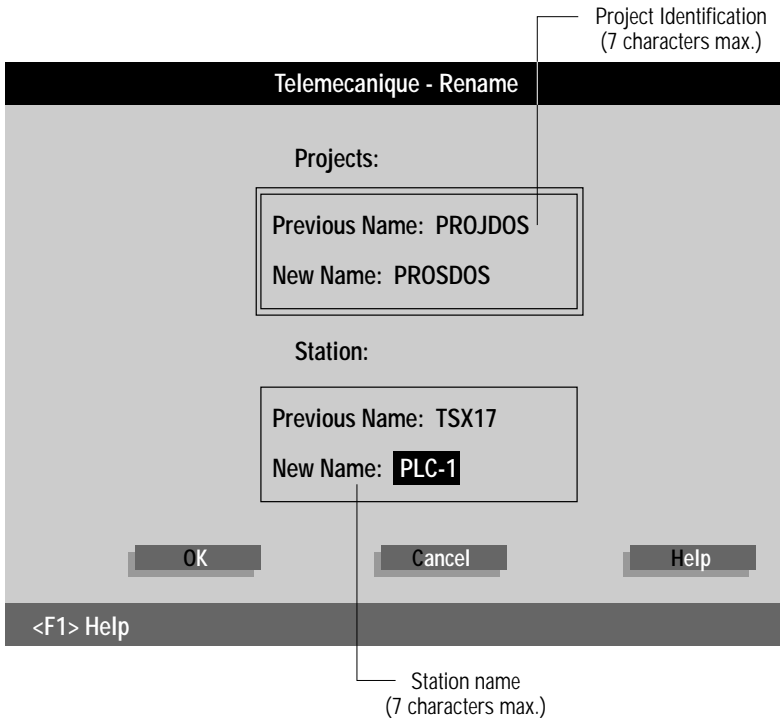

The change of name takes effect as soon as the command is confirmed.

4.2-7 Backup Command

This command lets the user save the current application on one or more diskettes and lets the user exchange applications between terminals equipped with the User Interface. This command is accessed by typing **B** in the Backup command. The following screen is displayed:

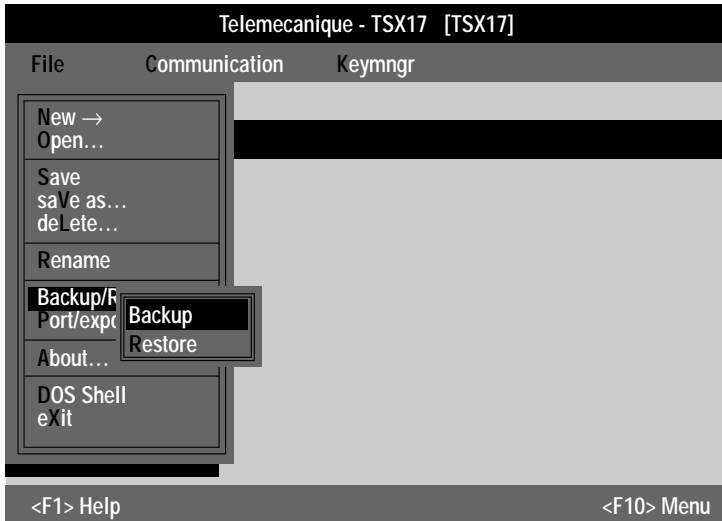

Selecting the Backup command displays the following window:

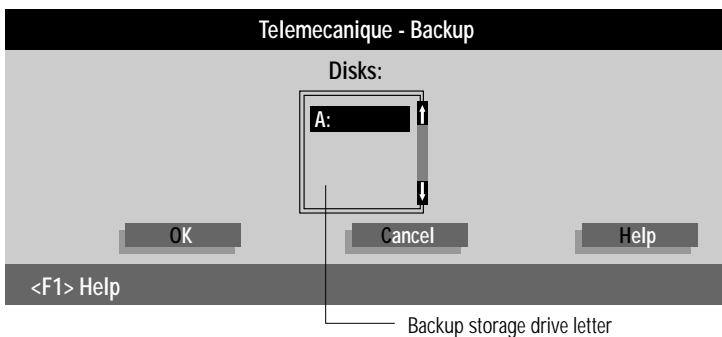

Once the command is confirmed, a message is displayed warning the user that any files already stored will be overwritten. The user can confirm the Backup action by selecting "OK". The terminal will then use the appropriate DOS commands to copy the files to one or more diskettes and number them in sequence, depending on the size of the project.



Note: This is a DOS Backup action.

4.2-8 Restore Command

This command lets the user restore an application previously saved on one or more diskettes, to the work field.

To access this command type **B** for the Backup command, then **R** for the Restore command. The following screen is displayed:

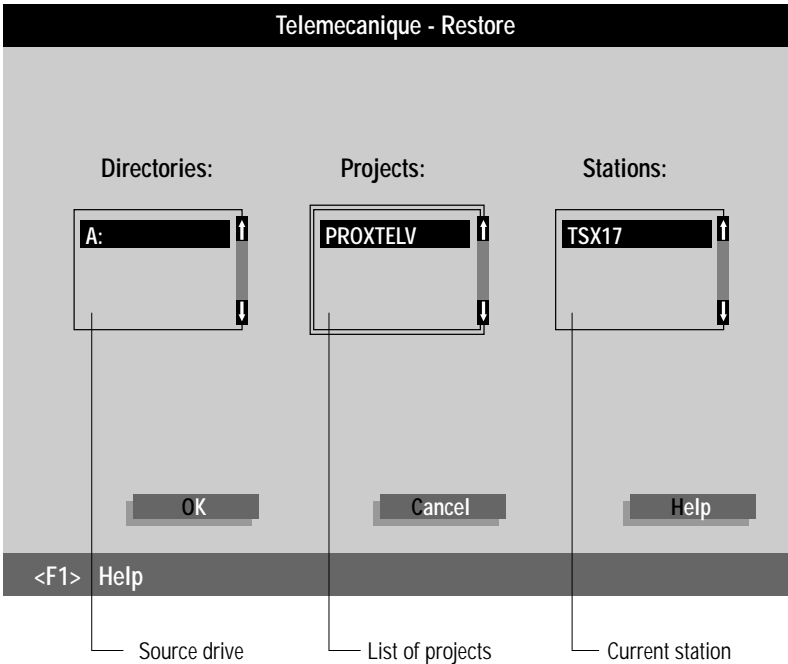

The selection bars allow the user to select from the lists. Once the selection is confirmed, the User Interface copies the application to the work field.



Note: This is a DOS Restore action.

4.2-9 Import Command

This command lets the user import files from any application tree layout to the terminal using a file tree layout that is coherent with that used by the User Interface.

This command is accessed by typing **I** then **I**. The following screen is displayed.

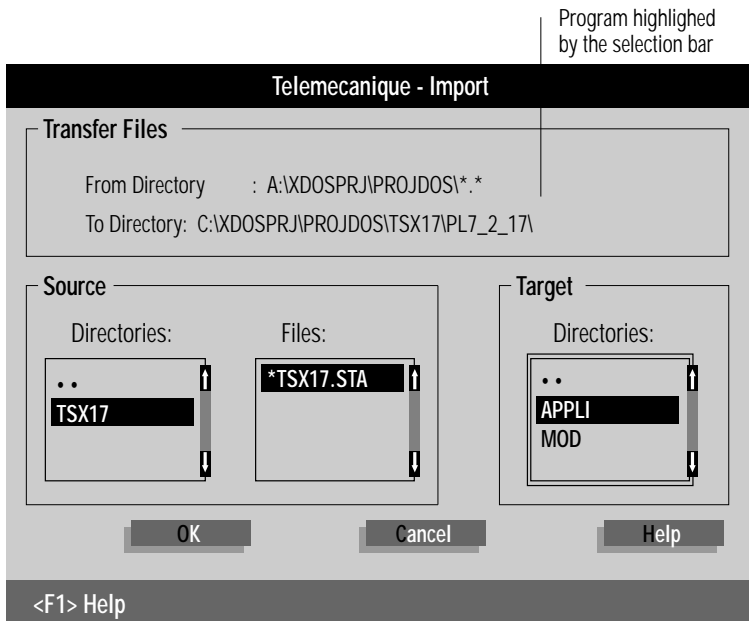

This function lets the user copy files to the work field from a diskette or a directory on a hard disk.

Operating mode

Using the cursor keys:

- 1 - Access the source field in the directory pull-down menu.
- 2 - Select the drive (diskette A: or hard disk C:).
- 3 - Progressively specify the location in the file storage tree layout of the source directories.
- 4 - Confirm the selection by pressing .
- 5 - Use the "File" pull-down menu to select the files to import by pressing repeatedly. The files to transfer will be identified by an asterisk.
- 6 - Press or to access the target field (pull-down menu for target directories).
- 7 - Select the target.
- 8 - Press to select the "OK" button.
- 9 - Press to confirm. File transfer will be performed.



Note:

The access path is shown in the: "File Transfer" field, Source → Target.

4.2-10 Export Command

This command lets the user export files from the work field to a directory in the file layout on the hard disk or to a diskette. Press **I** then **E**. The following screen is displayed:

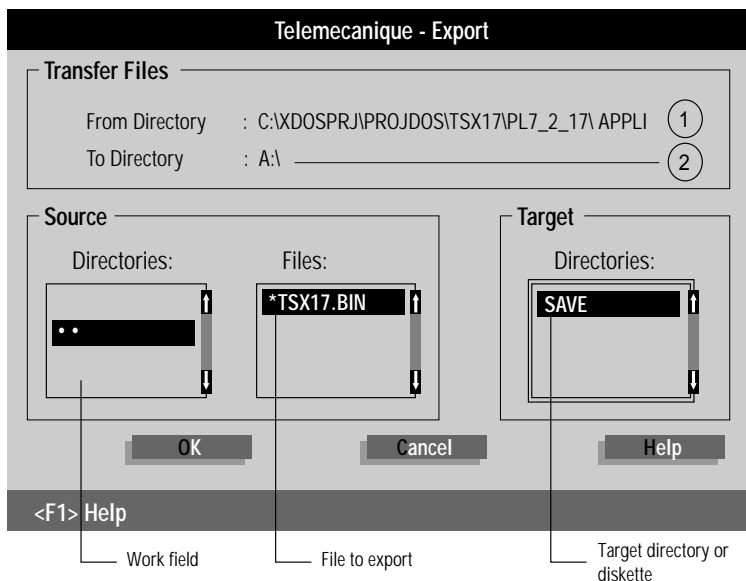

Operating mode

- 1 - Access the Source/Directories field and choose the source directory in the work field.
- 2 - Press **→** and then press **←** to select the files to export. Selected files will be shown with an asterisk.
- 3 - Press **TAB** to access the Target field.
- 4 - Press the **↓** and **←** keys to select the target directory.
- 5 - Press **TAB** once again and **←** to confirm the file export action.

- ① Export the TSX17.BIN file from the "APPLI" subdirectory that is accessed with:
C:\XDOSPRJ\PROJDOS\TSX17\PL7-2-17\APPLI
- ② To the diskette and directory A:\SAVE

4.2-11 About Command

This command displays version information on the User Interface. Type the keyboard shortcut **A**. The following message is displayed:

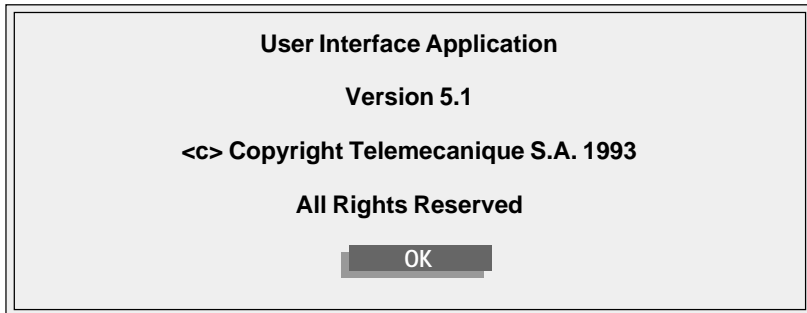

4.2-12 DOS Shell Command

This command lets the user return directly to the DOS operating environment. Type the keyboard shortcut **D**. A dialog box is displayed, as shown below:



4.2-13 Exit Command

This command lets the user exit the User Interface.

It is accessed by typing the keyboard shortcut **X**.

Confirming the action by selecting Ok will return the user to the DOS root directory.

The warning message shown below is displayed:



4.3 Communication Menu

This menu lets the user define the address of the station that is logically connected to the terminal and specify the communication driver used for exchanges between the terminal and the PLC.

Two commands can be selected:

- Address...
- Drivers

4.3-1 Address Command

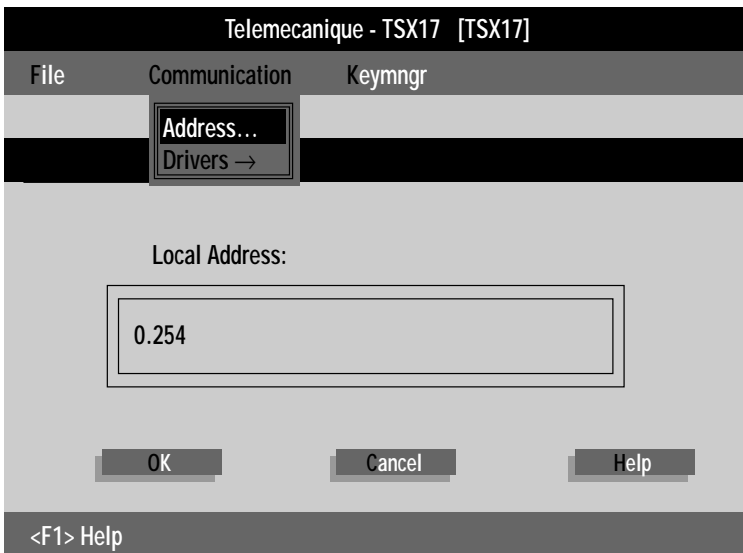

This command is accessed by typing the keyboard shortcut A and lets the user specify the logical address of the PLC to connect locally.

The default address is 0.254: The terminal is connected locally or remotely to the PLC.

Pressing  to confirm this action will save the specified address.

Local address description

- The local address lets the user identify the communication link between the terminal and the PLC when network connection is used.

If there is no network, the address is 0.254.

- If the station is part of a UNI_TELWAY, FIPIO/FIPWAY bus, the address is as follows:

1 - NETWORK FORMAT

Parameters to fill-in:

NN: Network address

SS: Station address

Hence the format: **NN.SS**

with $0 \leq NN \leq 127$

and $0 \leq SS \leq 63$

2 - UNI_TELWAY FORMAT

Parameters to fill-in:

Master station : NN.SS

Access Gate Number : 5

Master Rack-Module : rm

Station Channel : CC

Hence the format: **NN.SS.5.rm.CC**

with $0 \leq NN \leq 127$

$0 \leq SS \leq 63$

$0 \leq rm \leq 255$

$0 \leq CC \leq 255$

3 - FIPIO/FIPWAY FORMAT

Parameters to fill-in:

Network station address : NN.SS

Gate number : 8

Selector : sl

Connection point : pr

Station reference : rf

Hence the format: **NN.SS.8.sl.pr.rf**

with $0 \leq NN \leq 127$

$0 \leq SS \leq 63$

$0 \leq sl \leq 15$

$0 \leq pr \leq 63$

$0 \leq rf \leq 15$

4.3-2 Drivers

The communication driver is selected from the Communication menu and by typing the keyboard shortcut **D** for Drivers and by pressing **[↵]** to confirm.

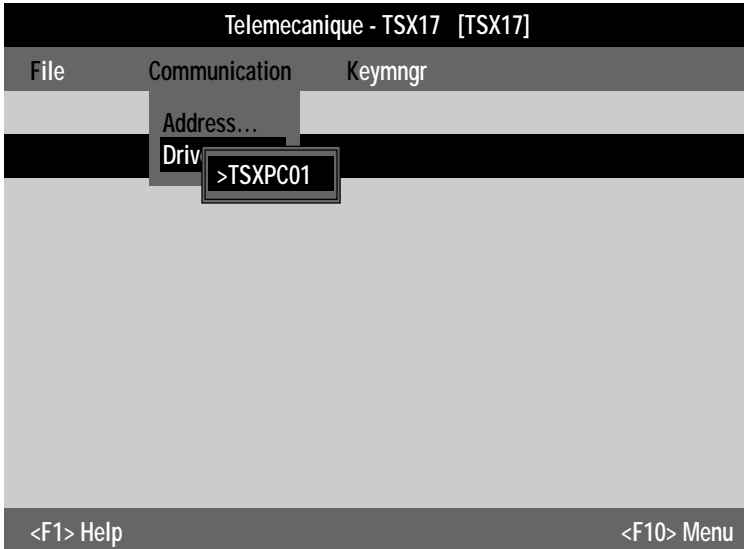

The possible drivers include:

- TSX → Prog. Port : TSX PC nn (the terminal is locally connected to the PLC).
- FIPWAY : FIPIONn (the terminal is physically connected to the network FIPWAY)
- UNI_TELWAY : UNITE nn (the terminal is physically connected to the UNI_TELWAY bus).
- nn : Driver instance number (user transparent).



Note:

When the communication driver is changed, the terminal must be restarted.

4.4 Keymgr Menu

Telemecanique programs (except PL7-1) are supplied with a protection key module that defines the user's rights of access to the program software.

The access rights are specific to each program and they can be merged into a single key.

The KEY MANAGER that is a standard part of the User Interface supports this operation.

Telemecanique FTX terminals are fitted as standard with two slots for protection key modules. For PC compatible computers, a TSX SCC 02 protection key module holder must be connected to the parallel port.

**Note:**

For a full description of how to use the Key Manager, refer to Section 5 in this manual.

4.5 Accessing a TSX L Program

4.5-1 Purpose

To access the User Interface in order to develop a PL7-2 application for a TSX 17-20 PLC.

4.5-2 Path Description

Invoke the User Interface automatically or by typing the following command from the terminal keyboard: TE ↵.

From the primary window, select the following commands in succession:

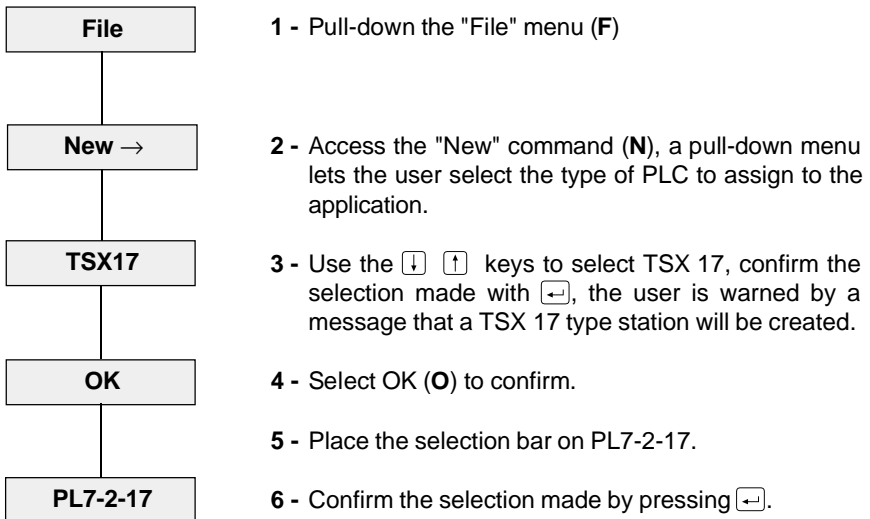

The PL7-2-17 program operating modes selection screen will be displayed. Refer to the appropriate Operating Modes documentation.

TERMINAL

PL7-2 TSX 17-20 Copyright  1993

Network Address

TERMINAL: Net=0 Station=254 TSX: Net=0 Station=254

Version

V5.0

Working Memory (WORK MEM)

0 - TERMINAL MEMORY
1 - TSX MEMORY

OPERATING MODE

0 - CONTROL
1 - CONFIGURATION
2 - PROGRAM
3 - CONSTANT
4 - ADJUST
5 - DATA
6 - DEBUG
7 - TRANSFER
8 - DOCUMENT / PRINT
9 - SEARCH / REPLACE
A - TERMINAL

Archive (ARCHIV)

ARCHIVE NAME: TSX17

Processor Type

TSX 17-20

OPERATING MODE

WORKMEM

EXIT

STORE

RETRIEVE

The user develops the application corresponding to the selected PLC station. Once the program transfer and debug phases have been performed, the application can be saved.

- 7 - Exit PL7-2-17 using the EXIT command (press **F3** or **↓** followed by **F9**) to return to the User Interface.



The archive storage name corresponds to the station name defined using the Rename command. By default, the archive storage name is the same as the station name.

Only station names of up to seven characters max. are recognized by PL7 programs.

- 8 - In the User Interface environment, access the "File" menu once again and select the "saVe as..." command.
- 9 - Fill-in the appropriate fields for saving the application.

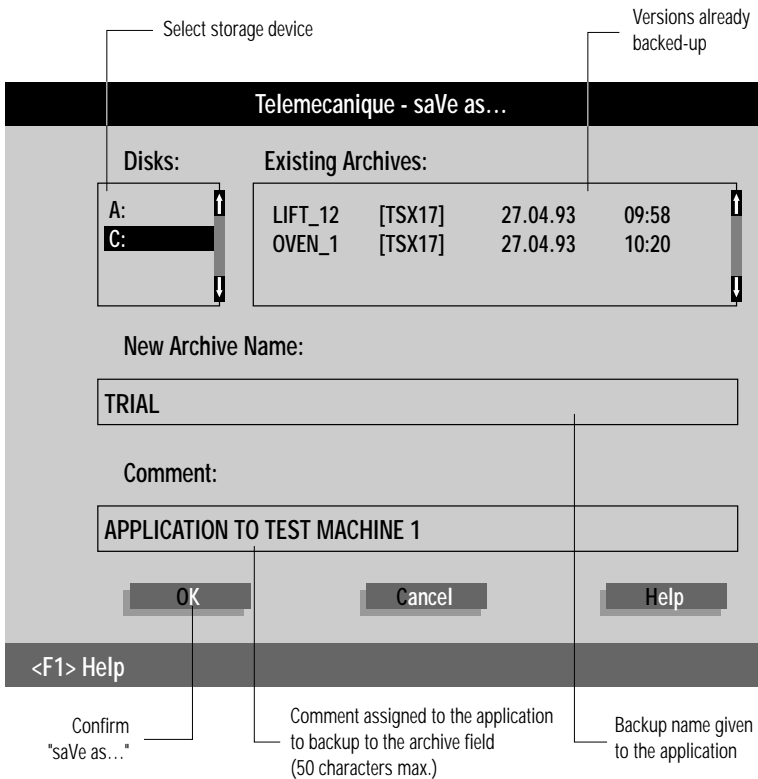

Once the command is confirmed, the User Interface can once again be used to select any accessible function.



Sub-section	Page
5.1 Presentation	5/2
5.2 Functions	5/4
5.2-1 Station Configuration	5/4
5.2-2 Using the Station	5/5
5.2-3 Running an Application after a Key Module Failure	5/6
5.3 Accessing the Key Manager	5/7
5.4 Action Menu	5/9
5.4-1 Read Action	5/9
5.4-2 Transfer Action	5/10
5.4-3 Backup Action	5/11
5.4-4 Restore Action	5/13
5.4-5 Create Action	5/15
5.4-6 Increment Action	5/17
5.5 Key Module Markings	5/19
5.5-1 General	5/19
5.5-2 Example	5/20

5.1 Presentation

The Key Manager function is accessed from the primary window in the User Interface. Telemecanique programs (except PL7-1 for TSX 17) are supplied with a software key module (original key) that contains its rights of use.

The original key module lets the user access the basic functions of the User Interface. The various PL7-X programs are individually protected with their own original key modules.

In order to access a number of programs simultaneously on the same machine, the various rights of use should be combined into a single key module. The Key Manager accessed from the User Interface handles the various steps that ensure that the user has a usable work key module.

When the Key Manager is invoked, the following screen is displayed:

The screenshot shows the KEYMANAGER interface with two slots, SLOT A and SLOT B. SLOT A contains a key module with the following details:

- Work Key No. 030500350
- (Associate Key No. 030500216)
- Table with columns Bkp, Symbol, and Cat:

Bkp	Symbol	Cat
B	TSX L PL7 2 V5	(TE4)
B	TSX L PL7 22 V5	(TE4)

- Symbol: TSX L PL7 2 V5
- Comment: PL7-2 DOS for TSX 17-20

SLOT B is currently empty:

- Empty Key No. 030500218
- (-----)
- Table with columns Bkp, Symbol, and Cat (empty).
- Symbol: (empty)
- Comment: (empty)

At the bottom, there are navigation options: <F1> Help and <F10> Menu.

The first Key Manager screen displays the characteristics of the key modules (key number and type, rights of access that it contains, etc.) present in the key module holder.

The user can pull-down two menus from the action bar, enabling selection of an action to perform.

Various steps are required to ensure that the user has a usable work key module.

A key module can take seven different states:

- **Original key module:**

The key module supplied with the program contains the original right of use.

- **Work key module:**

The key module comprises the rights of use after the backup key has been made.

- **Backup key module:**

A copy of the rights of use available for backup purposes.

- **Help (emergency) key module:**

A key module that lets the user continue to use the program for a limited amount of time after a work key module failure.

- **Empty key module:**

A key module after its rights of use have been transferred.

- **Temporary pass key module:**

A key module with a limited service life that lets the user continue to use all Telemecanique programs in X-TEL, MINI X-TEL or DOS (User Interface).

- **Incremental key module:**

A key module that is used to upgrade the rights of use in an original key module to the latest version.

5.2 Functions

5.2-1 Station Configuration

Telemecanique programs are supplied with a software key module with a right of use. This key module is called the original key module.

Before using the software key module, the user must perform the steps described in this section.

Transfer the right of use

To use a number of different programs simultaneously, combining their rights of use into a single software key module is recommended. This operation comprises transferring the rights. A right of use can only be transferred from an original key module.

Once a transfer has been completed, for as many rights of use as required, a single work key module contains all of the rights of use. The original key modules have become empty key modules.

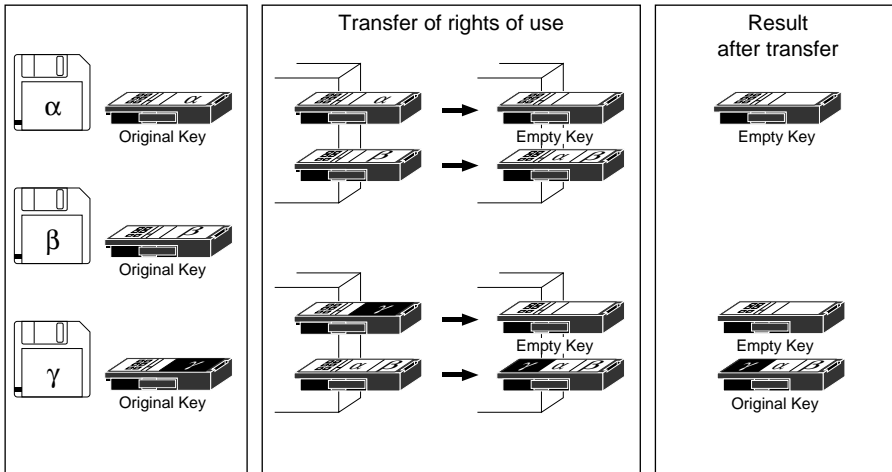

Note:

The reverse action to union of the various rights of use restores them to their original software key modules.

5.2-2 Using the Station

Once the rights of use have been transferred to a single original software key module, it is strongly recommended that a backup key module be made.

The backup operation creates a backup key module that the user should be sure to store in a safe place. It is now possible for the user to start using the station with the work key module just created.

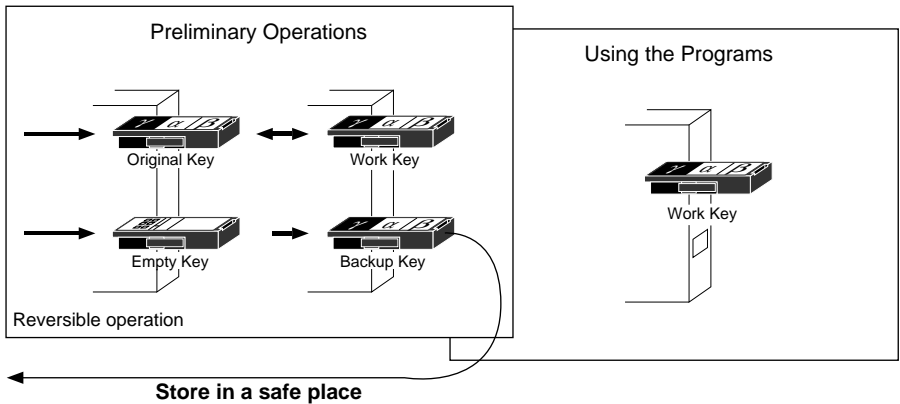

The backup key module is created using a empty key module.

Note:

The reverse operation, returning the rights of use to the original software key modules, regenerates an original key from a work key module and a backup key.

Normal operation of the station is only possible with a work key module that contains the rights of use for all of the programs that are installed on the station.

A program can only be started if its right of use is present.

During program execution, a regular check is made to ensure that the correct right of use is present in the work key module.

If the work key module fails or is removed, the program informs the user that any work in progress must be saved immediately and the station correctly and completely. After approximately 10 minutes, the program stops execution making it impossible to save any data on the application if it is still open.

The backup key module should be kept in a safe place. It does not allow the user to use the rights it contains directly, this is only possible with the work key, but it does let the user:

- Create an help key module that provides approximately 200 hours of operation, giving time to procure a replacement for the failed work key module.
- A means of proving the rights of use that were originally transferred to the work key module should the latter fail.

5.2-3 Running the Application after a Key Module Failure

Despite the care taken during production of the software key modules, it is always possible that a failure may occur occasionally.

To ensure that the user can continue to use their programs while a replacement is being obtained, a help key module can be created.

The help key module supports approximately 200 hours of operation, equal to approximately 25 eight hour working days.

The time base retained is 15 minutes. This means that the working life of the help key module is reduced by 15 minutes each time one of the programs that it contains a right of use for remains in service for 15 minutes.

When the 200 hours available are used up, the help key module can no longer be used. Its service life cannot be extended.

As soon as a failure is detected on a station, the user should:

- Save work in progress,
- Retrieve the backup key previously stored in a safe place and along with the failed work key module and an empty key module, proceed to create an help key module,
- Create an help key module (Create action). When this action is complete, the backup key module will become an “inhibited key module”, no longer able to generate help key modules and the empty key module becomes the help key module that allows operation to proceed,
- Return the failed work key module and the inhibited key module to Telemecanique for replacement.

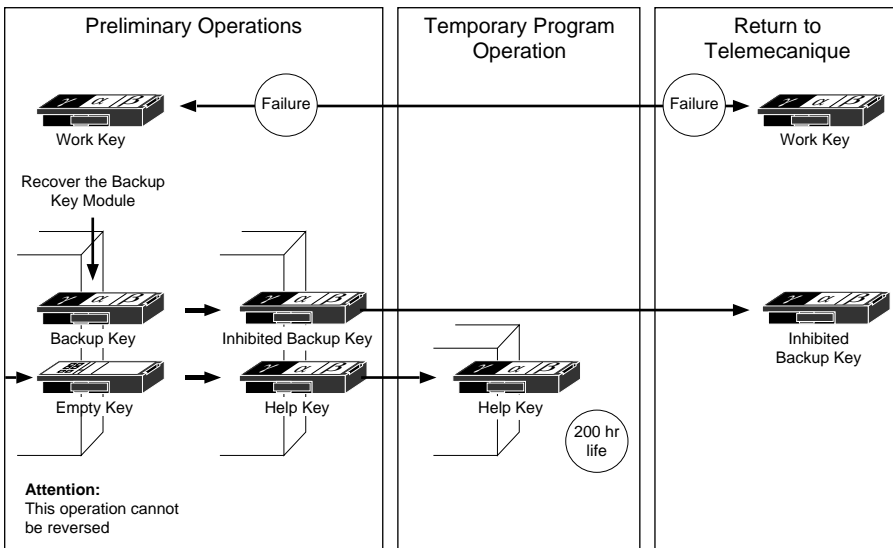

5.3 Accessing the Key Manager

The Key Manager is accessed from the KeyMgr menu in the User Interface screen.

Primary window

KEYMANAGER		
Action	Exit	
SLOT A		
Work Key No. 030500350 (Associate Key No. 030500216)		
Bkp	Symbol	Cat
B	TSX L PL7 2 V5	(TE4)
B	TSX L PL7 22 V5	(TE4)
Symbol TSX L PL7 2 V5		
Comment PL7-2 DOS for TSX 17-20		
SLOT B		
Empty Key No. 030500218 (-----)		
Bkp	Symbol	Cat
Symbol		
Comment		
<F1> Help		<F10> Menu

The Key Manager primary window displays the characteristics of the key modules (serial number and type of key module, rights of use available, etc.) located in the key module holder slot. This window is described in detail in sub-section 5.4-1.

This window lets the user select an action to execute from those proposed in the two menus displayed by accessing the action bar.

Diagram

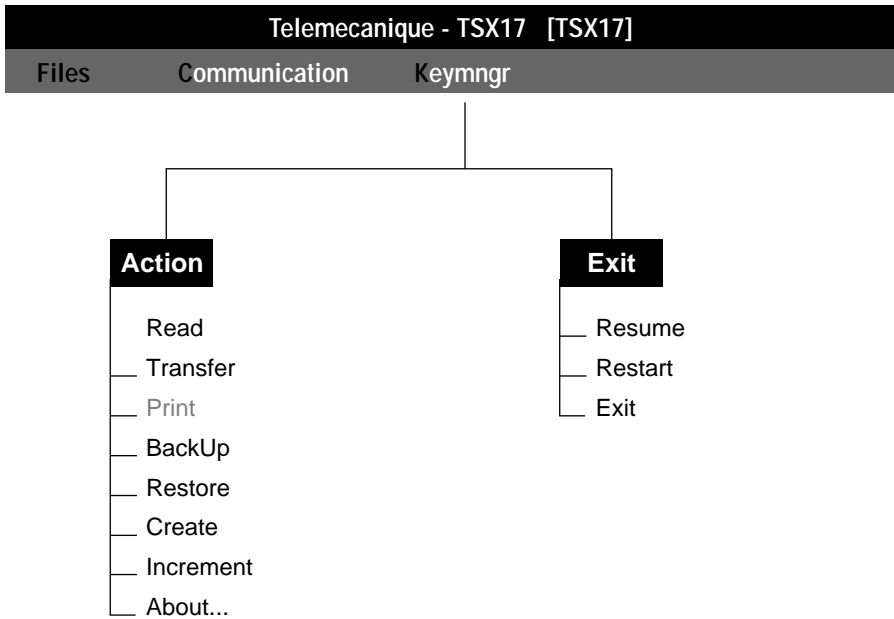

5.4 Action Menu

5.4-1 Read Action

This window lets the user display the contents of the key modules inserted in key slots A and B of the FTX 507 or FTX 417 terminal or the TSX SCC 02 key module holder when using an IBM PS/2 or compatible microcomputer.

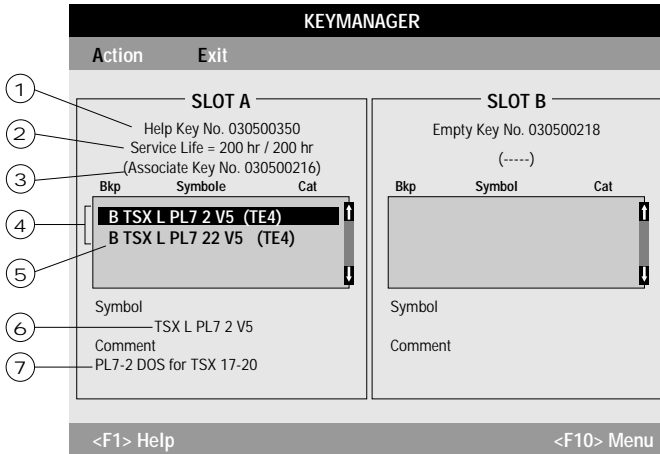

This screen displays the following information for each key module:

- ① its type and serial number,
- ② the remaining amount of working time available in the case of a Help (emergency) key module,
- ③ the serial number of the associate key module,
- ④ the rights of use available.

For each right of use in a key module, the screen displays:

- ⑤ whether it has been backed-up ("B" shown in the Bkp column),
- ⑥ the program catalog reference (shown in the Symbol column),
- ⑦ the full name of the program (shown in the Comments field).

The data contained in the Category field is reserved for use by Telemecanique.

5.4-2 Transfer Action

The transfer action lets the user transfer rights of use from one key module to another. It lets the user combine or merge a number of rights of use for different programs into the same key module.

Before starting the transfer action, the user should select the right(s) of use to be affected by the operation and located in the original key module, identified by its location (Transfer A B or B A).

Once this selection has been made, the following screen is displayed:

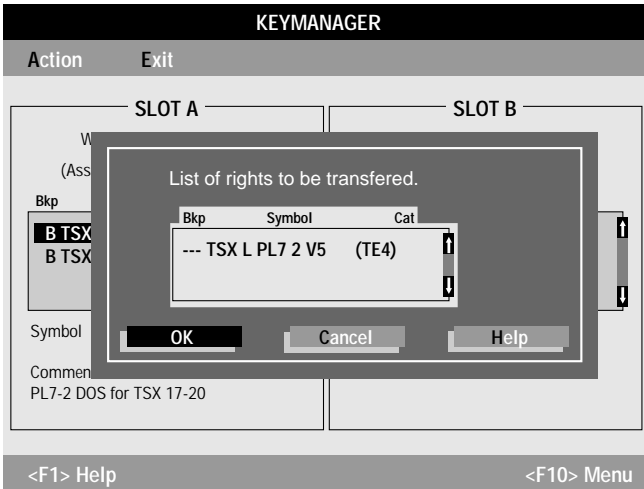

OK Transfers the selected rights of use,

Cancel Cancels the transfer and returns the user to the primary window of the Key Manager.

5.4-3 Backup Action

The Backup action should be used before any application program is used on the station.

This operation requires inserting a key module into both slots A and B:

- The original key module with the various rights of use for the programs to be used, and
- An empty (blank) key module.

Once the backup operation is complete,

- The original key module becomes the work key module, and
- The empty key module becomes a backup key module.

The screen shown below displays the status of the two key modules before the backup action is performed:

KEYMANAGER		
Action	Exit	
— SLOT A —		
Original Key No. 000024024 (-----)		
Bkp	Symbol	Cat
B	TSX L PL7 2 V5 (TE4)	
B	TSX L PL7 22 V5 (TE4)	
Symbol TSX L PL7 22 V5		
Comment PL7-2 DOS TSX 17-20		
— SLOT B —		
Empty Key No. 000024004 (-----)		
Bkp	Symbol	Cat
Symbol		
Comment		
<F1> Help		<F10> Menu

Selecting the Backup action causes the following screen to be displayed:

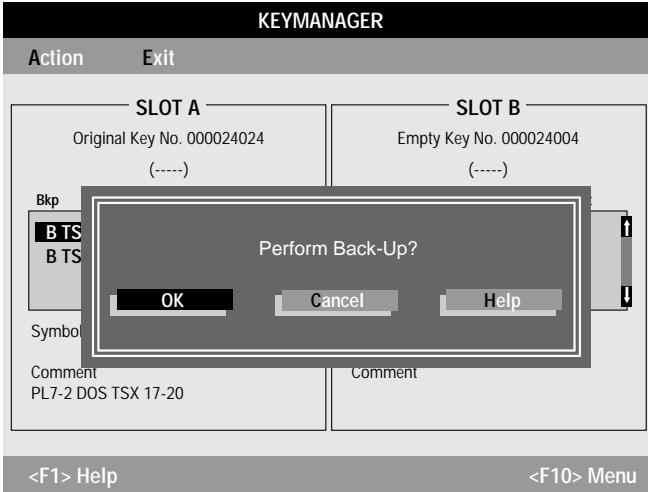

- Cancel** Cancels the request and returns the user to the primary window of the Key Manager function.
- OK** Starts the Backup procedure and displays the following screen:

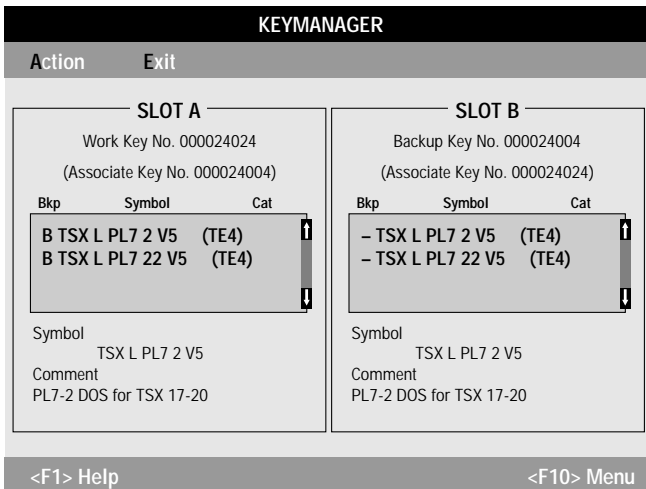

5.4-4 Restore Action

The Restore action has the opposite effect to the Backup action.

This operation requires inserting a key module into both slots A and B:

- The work key module with the various rights of use for the programs used, and
- The appropriate backup key module for the work key module.

Once the Restore procedure is complete,

- The work key module becomes the original key module again. Therefore the rights of use that it contains can be transferred to another key module using the Transfer action, and
- The backup key module becomes an empty key module again.

The screen shown below displays the status of the two key modules before the restore action is run:

KEYMANAGER		
Action	Exit	
SLOT A		
Work Key No. 000024024 (Associate Key No. 000024004)		
Bkp	Symbol	Cat
	B TSX L PL7 2 V5(TE4)	
	B TSX L PL7 22 V5 (TE4)	
Symbol TSX L PL7 2 V5		
Comment PL7-2 DOS for TSX 17-20		
SLOT B		
Backup Key No. 000024004 (Associate Key No. 000024024)		
Bkp	Symbol	Cat
	- TSX L PL7 2 V5(TE4)	
	- TSX L PL7 22 V5(TE4)	
Symbol TSX L PL7 2 V5		
Comment PL7-2 DOS for TSX 17-20		
<F1> Help		<F10> Menu

Selecting the Restore action displays the following screen:

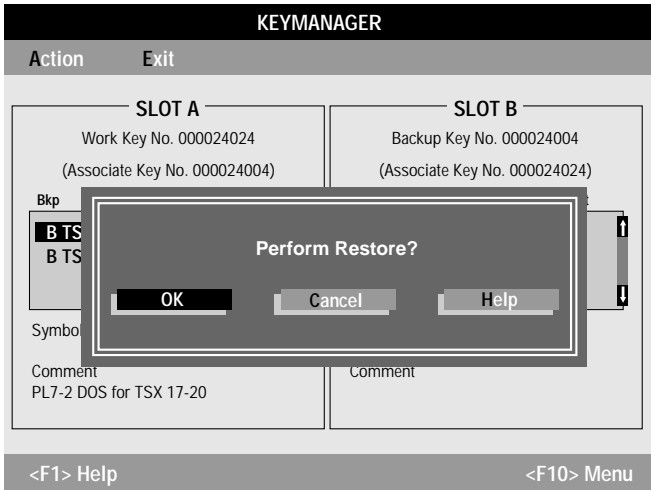

Cancel Cancels the request and returns the user to the main screen of the Key Manager.

OK Starts the Restore procedure and displays the following screen:

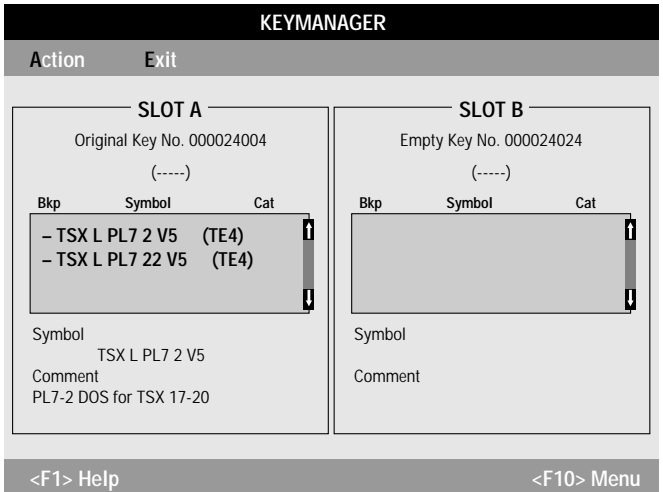

5.4-5 Create Action

This action lets the user create a help key module in order to continue working in the event of a work key module failure.

This operation requires inserting a key module into both slots A and B:

- The backup key module for the failed work key module, and
- An empty key module.

Selecting the Create action causes the following screen to be displayed:

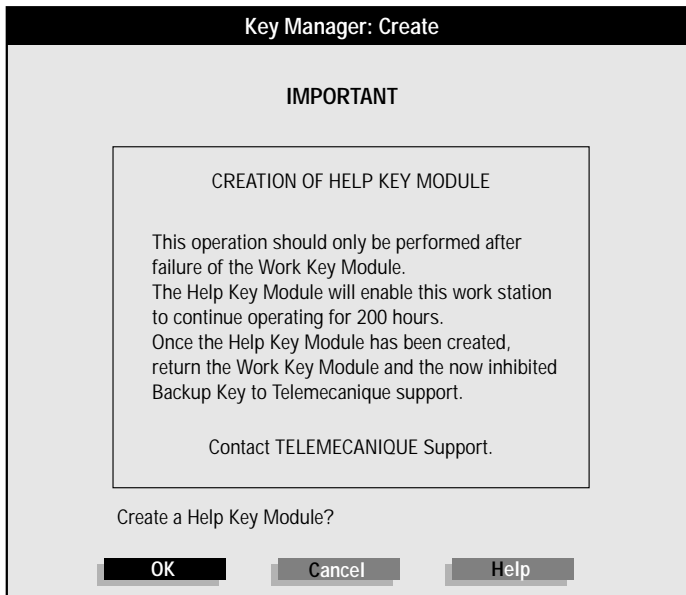

OK Starts the help key module create procedure,

Cancel Cancels the create action and returns the user to the primary window of the Key Manager,

Help Displays on-line help.

Once the help key module has been created, the following screen displays the status of the two keys:

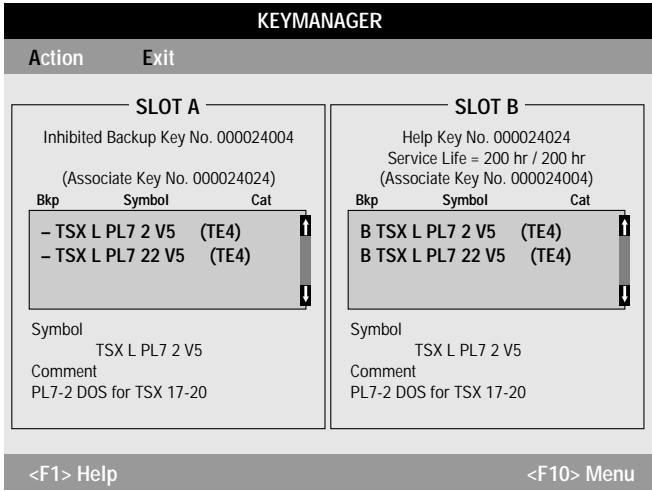

When this operation is complete,

- The backup key module becomes an inhibited backup key module and cannot be used,
- The empty key module becomes a help key module. A help key module lets the user continue to use the application programs for up to 200 working hours.

Warning:

The faulty work key module and the inhibited backup key module must both be returned to Telemecanique together for replacement.

5.4-6 Increment Action

The increment action, with an incremental key module and an original key module containing the right of use for version level n of a program, allows the user to create a new original key module with the right of use for the same program at version level $n+1$. This action therefore allows the user to update an existing installed base of systems (e.g. upgrading from PL7-2 version V3 to PL7-2 version V5).

This operation requires inserting key module in both slots A and B:

- The incremental key module with the updated rights of use,
- The original key module containing the initial right of use for the program used.

Activating the increment action displays the dialog box shown on the next page.

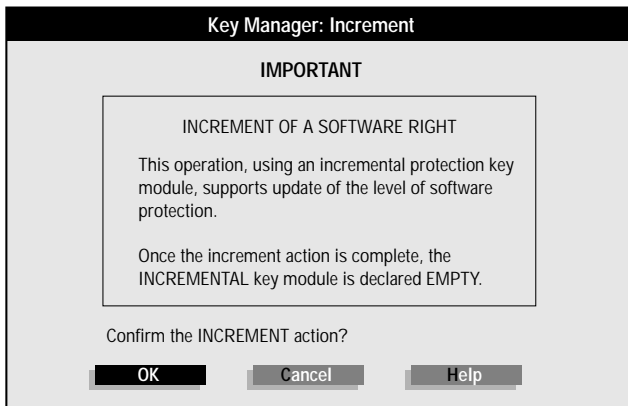

OK Runs the incrementation procedure

Cancel Cancels the incrementation procedure and returns the user to the Key Manager primary window.

Once the increment action is complete,

- The original key module containing the right of use for version level n becomes the original key module containing the right of user for version level n+1. Therefore all of the rights of use that it contains can be transferred to another key module using the Transfer action.
- The incremental key module becomes an empty key module.

The screen below shows the status of the two key modules once the increment action is complete.

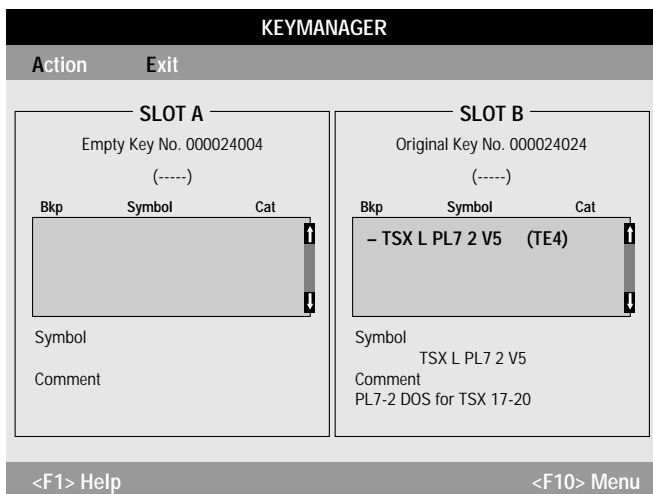

5.5 Key Module Markings

5.5-1 General

The labels on the key modules are essential for ease of use, enabling:

- Identification of the type of key,
- Listing the rights of use contained in the key module,
- Displaying the key module serial number.

Label description

- ① Key module serial number.
- ② Type of key module:
 Empt = Empty key module,
 Orig = Original key module,
 Work = Work key module,
 Back = Backup key module,
 Inhi = Inhibited backup key module,
 Help = Help key module.
- ③ Type and serial number of the associate key module.
- ④ Application program rights of use transferred to the key module.

Serial number	xxxxxxx
Module Type	
Empt	<input type="checkbox"/>
Orig	<input type="checkbox"/>
Work	<input type="checkbox"/>
Back	<input type="checkbox"/>
Inhi	<input type="checkbox"/>
Help	<input type="checkbox"/>
Associate module	
Type Serial Num	
Telemechanique Software	

It is recommended that the user fill-in the labels completely and correctly as the various operations are performed.

5.5-2 Example

Reception of two application programs



Program 1

Serial number 9170022		
Module Type		
Empt <input type="checkbox"/>	Orig <input type="checkbox"/>	Work <input type="checkbox"/>
Back <input type="checkbox"/>	Inhi <input type="checkbox"/>	Help <input type="checkbox"/>
Associate module Type Serial Num		
Telemecanique Software		
TSX L PL7 22V5		

Key Module 1



Program 2

Serial number 9180023		
Module Type		
Empt <input type="checkbox"/>	Orig <input type="checkbox"/>	Work <input type="checkbox"/>
Back <input type="checkbox"/>	Inhi <input type="checkbox"/>	Help <input type="checkbox"/>
Associate module Type Serial Num		
Telemecanique Software		
TSX L SYD V5		

Key Module 2

Merging rights in to Key Module 1



Serial number 9170022		
Module Type		
Empt <input type="checkbox"/>	Orig <input checked="" type="checkbox"/>	Work <input type="checkbox"/>
Back <input type="checkbox"/>	Inhi <input type="checkbox"/>	Help <input type="checkbox"/>
Associate module Type Serial Num		
Telemecanique Software		
TSX L PL7 22V5		
TSX L SYD V5		

Key Module 1



Serial number 9180023		
Module Type		
Empt <input checked="" type="checkbox"/>	Orig <input type="checkbox"/>	Work <input type="checkbox"/>
Back <input type="checkbox"/>	Inhi <input type="checkbox"/>	Help <input type="checkbox"/>
Associate module Type Serial Num		
Telemecanique Software		
TSX L SYD V5		

Key Module 2



Sub-Sections		Page
6.1	Using the PROM Programmer	6/2
	6.1-1 Primary Window Description	6/2
	6.1-2 Function Key Actions	6/3
6.2	Selecting the Serial Port	6/4
6.3	Using the funcTion Menu	6/5
6.4	Using the File Menu	6/6
6.5	Selecting funcTion	6/7
	6.5-1 PL7-1/PL7-2 Single-Cartridge Application	6/7
	6.5-2 PL7-3 Single-Cartridge Application	6/8
	6.5-3 PL7-3 Multiple-Cartridge Application	6/10

6.1 Using the PROM Programmer

The **PROM Programmer** function is used to write EPROM type memory cartridges used to store PLC application programs.



Note:

The **applications** for **V3 type** stations must be **imported** into the User Interface so that they can be processed by the **PROM Programmer**.

To use this function, the TSX TPE 01 cartridge programmer must be connected to the terminal.

6.1-1 Primary Window Description

The primary screen lets the user access three pull-down menus for:

- Parametering the connection between the cartridge programmer and the terminal,
- Selecting the binary file to transfer,
- Determining the function to execute (write, read, compare).



```
PROM PROGRAMMER - TSX17 [TSX17]
File      funcTion  Port
-----
FUNCTION :          WRITE
FILE_NAME :        TRIAL_1
SERIAL PORT :      COM1

Cartridge
UVP 8K08 UTIL.
Blank

TELEMECANIQUE Copyright 1993
<F1> Help                                <F10> Menu
```

6.1-2 Function Key Actions

<F1> Help: Calls-up the on-line help screens.

<F10> Allows access to the action bar to select a pull-down menu (File, funcTion, Port). A menu is selected by moving the reverse video highlighting with the   keys or by typing the keyboard shortcut for the appropriate menu (e.g.: **funcTion - T**).



Note:

Pressing  returns the user to the User Interface.



Confirms a selection.



Cancels the current command.

6.2 Selecting the Serial Port

The serial port selection screen is accessed by typing the keyboard shortcut **P** the following screen is displayed:

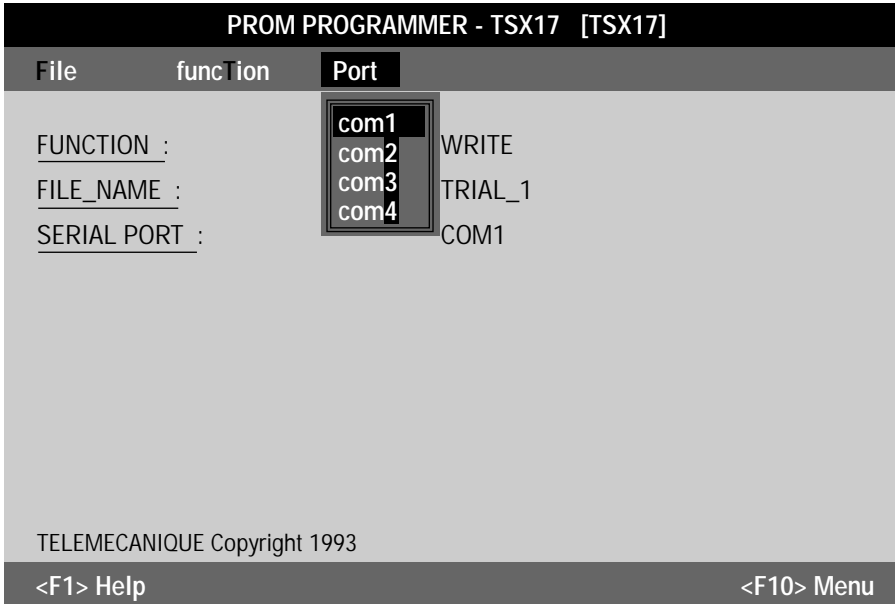

The **↓** **↑** keys let the user move the selection bar to the appropriate serial port. Typing the number of the port (e.g.: **com2**) will also select the port to connect.

The **↵** key confirms the selection made and displays the primary screen with the selected serial port shown. If the port does not exist or is not the one that the cartridge programmer is connected to, an error message is displayed on-screen.

6.3 Using the funcTion Menu

This menu is used to determine the type of action to perform. The pull-down menu can be selected by pressing the keyboard shortcut **T**, the following screen is displayed:

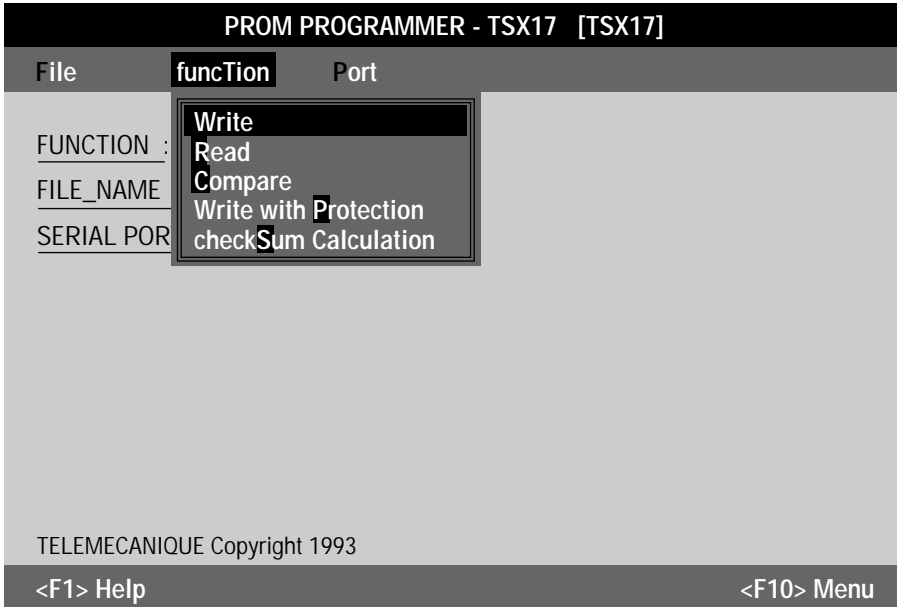



funcTion menu description

- **Write:** Transfers the application to the cartridge installed in the cartridge programmer.
- **Read:** Creates a binary application file from the data in the memory cartridge in the cartridge programmer.
- **Compare:** Compares the contents of a memory cartridge with the contents of the corresponding file.
- **write with Protection:** Transfers the application to the memory cartridge installed in the cartridge programmer and inhibits read/write access to it by Telemecanique terminals (PL7-1 and PL7-2 only).
- **calculate checkSum:** Defines the value in hexadecimal notation of the contents of the memory cartridge (source → cartridge coherence check).

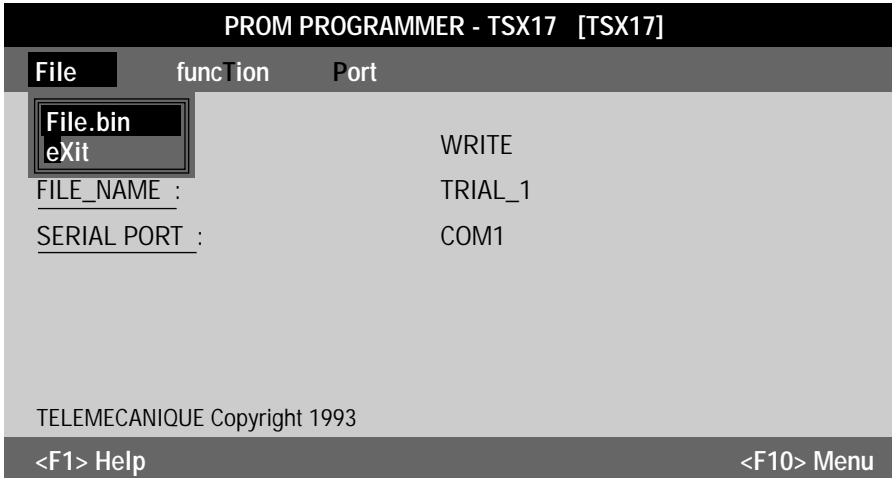

6.4 Using the File Menu

This menu lets the user select the binary file to transfer to the memory cartridge or quit the PROM Programmer function and return to the User Interface.

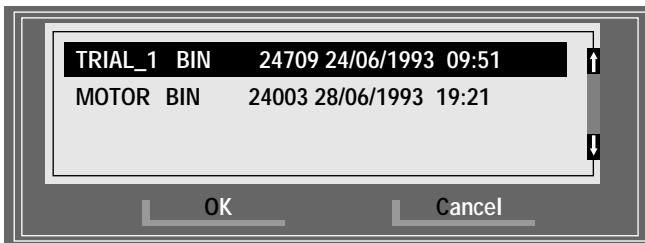

The user can select the binary file to access by pressing  or typing the keyboard shortcut **F**, the following window is displayed:



The binary files stored in the directory are listed in a window (as shown above), where the name of each file, its size in bytes, the date and time it was created are displayed. The   let the user select the file to transfer.

Pressing  confirms the selection made and displays the primary screen and the selected binary file.

If the Read function is selected, the source for the data from the memory cartridge can be:

- Not defined (no existing file)
- Defined (existing file - backed-up - protected)

in all cases, a menu lets the user determine the name of the target file from the data transferred.

6.5 Selecting function

Once the various selections are made, (file.bin, port), this action can be selected.

There are three possible cases:

- PL7-1/PL7-2 single-cartridge application,
- PL7-3 single-cartridge application,
- PL7-3 multiple-cartridge application.

6.5-1 PL7-1/PL7-2 Single-Cartridge Application



From the funcTion menu, pressing  executes the source or target transfer for the selected binary file.

Transfer progress is displayed on-screen in real-time. The user is informed that the operation is complete when the message "FUNCTION COMPLETED" is displayed.

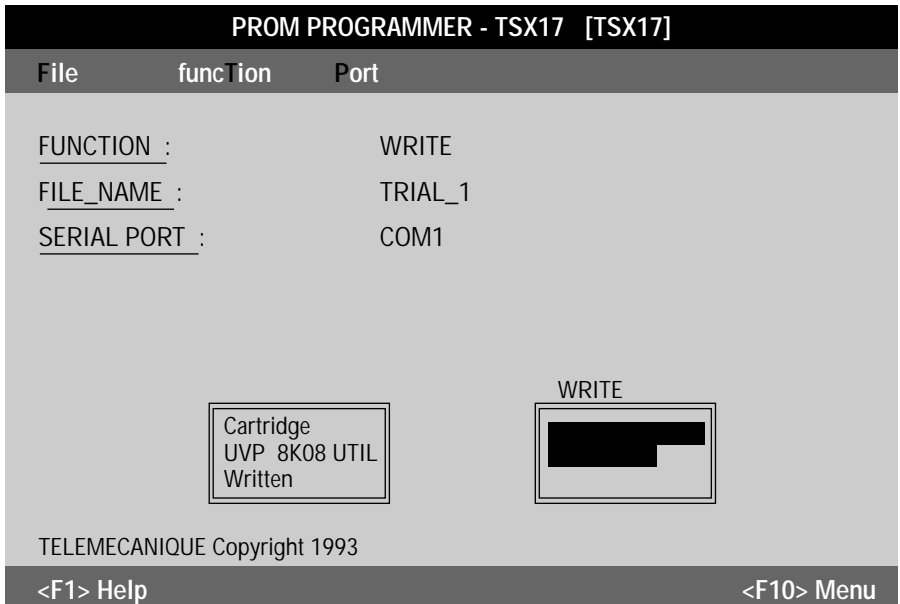
The screen below shows the action of writing to a cartridge in the programmer.



6.5-2 PL7-3 Single-Cartridge Application

From the funcTion menu, pressing  displays the screen shown below, that shows the word memory layout (part of the cartridge memory, refer to the V3 Reference Manual - Section 3) and places a cursor symbolizing the memory cartridge, in the memory layout. This cursor can be moved in increments of 8 Kwords using the   keys.

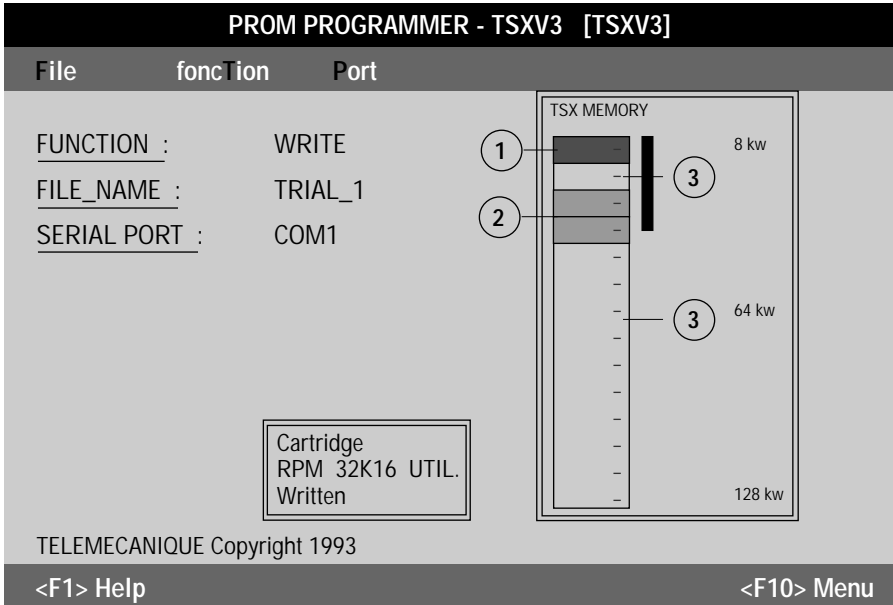

PROM PROGRAMMER - TSXV3 [TSXV3]

File funcTion Port

FUNCTION : WRITE

FILE_NAME : TRIAL_1

SERIAL PORT : COM1

Cartridge
RPM 32K16 UTIL.
Written

TSX MEMORY

1 2 3 8 kw

3 64 kw

128 kw

TELEMECANIQUE Copyright 1993

<F1> Help <F10> Menu

- ① Data field (cannot be stored on an EPROM cartridge),
- ② Program and constants field,
- ③ Blank memory space.

The transfer is executed by pressing . The binary file transferred is the one determined when selections were made from the funcTion menu. Transfer progress is displayed on-screen as shown below:

PROM PROGRAMMER - TSXV3 [TSXV3]

File	funcTion	Port
<u>F</u> UNCTION :	WRITE	
<u>F</u> ILE_NAME :	TRIAL_1	
<u>S</u> ERIAL PORT :	COM1	

Cartridge
RPM 32K16 UTIL.
Written

TELEMECANIQUE Copyright 1993

TSX MEMORY

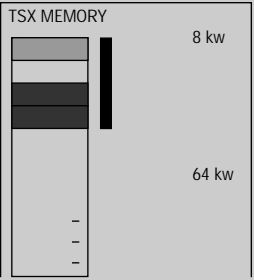

WRITE

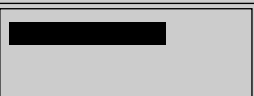

FUNCTION COMPLETED

<F1> Help
<F10> Menu

The user is informed that the operation is complete when the message "FUNCTION COMPLETED" is displayed.

6.5-3 PL7-3 Multiple-Cartridge Application

The access procedure is identical to that used for a PL7-3 single-cartridge application, by pressing .

The main differences are:

- READ is impossible,
- The user must use the cursor to define the memory segments to write or compare for each memory cartridge (as shown in the screen below).

Precautions to follow:

- Correctly identify the memory cartridges to avoid all confusion when inserting them into the PLC,
- Define the memory fields for each cartridge, taking care to avoid any overlaps.

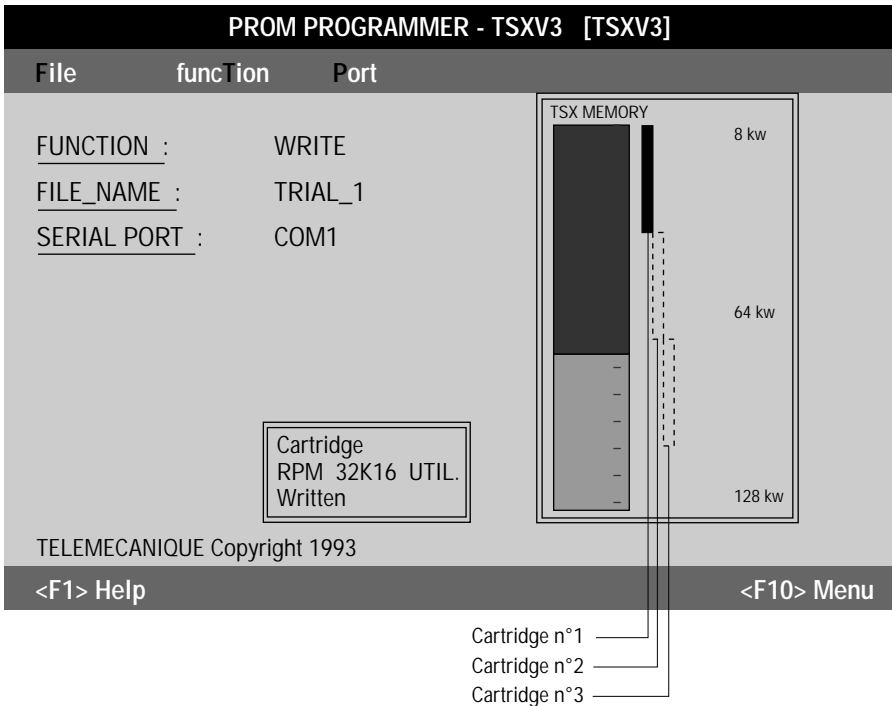

PROM PROGRAMMER - TSXV3 [TSXV3]

File	function	Port
<u>FUNCTION</u> :	WRITE	
<u>FILE_NAME</u> :	TRIAL_1	
<u>SERIAL PORT</u> :	COM1	

Cartridge RPM 32K16 UTIL. Written

TELEMECANIQUE Copyright 1993

<F1> Help <F10> Menu

TSX MEMORY



- 8 kw
- 64 kw
- 128 kw

Cartridge n°1

Cartridge n°2

Cartridge n°3

The Cartridge 1 - 2 and 3 markers identify the memory fields used by each selected segment. After pressing , progress of the transfer action is displayed on-screen in real-time. The user is informed that the operation is complete when the message "FUNCTION COMPLETED" is displayed.

The   keys let the user select the memory segments that apply to memory cartridges 2 and 3.



Sub-Sections	Page
7.1 Program Storage Tree Layout in the User Interface	7/2
7.2 Application File Organization	7/3
7.3 Application Migration from PL7-1/2 V3 to V5	7/4
7.3-1 V3 Level	7/4
7.3-2 V5 Level	7/4
7.4 PL7-2 Application Migration in the Software Workshop	7/5
7.5 Installing a Utility Program	7/6
7.5-1 Purpose	7/6
7.5-2 Operating Mode	7/6
7.5-3 Conclusion	7/8
7.6 Telemecanique Help	7/9
7.7 List of Help Topics	7/10
7.8 RAM Requirements	7/11
7.9 Installing a PL7-3 V3 Program	7/11
7.9-1 Introduction	7/11
7.9-2 Installing PL7-3 Under DOS	7/12
7.10 Glossary	7/13
7.11 Forcing User Interface Parameters	7/14

7.1 Program Storage Tree Layout in the User Interface

The access path to programs installed in the User Interface is shown below.

Path: C:\XDOSSYS\EXE

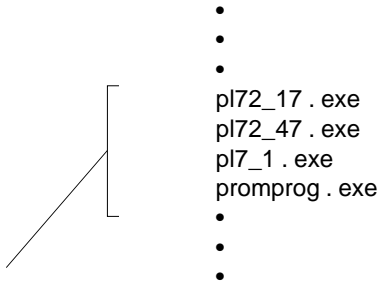

List of functions installed

The **New** → command in the File menu lets the user select the appropriate PL7 function for the PLC used.



Example:

- 1 - TSX17_1 station: The User Interface displays PL7-1 and PROM PROGRAMMER in the primary window.
- 2 - TSX27-47 station: The User Interface displays PL7-2-27/47 and PROM PROGRAMMER in the primary window.

7.2 Application File Organization

Files linked to applications are stored as shown below:

C:\

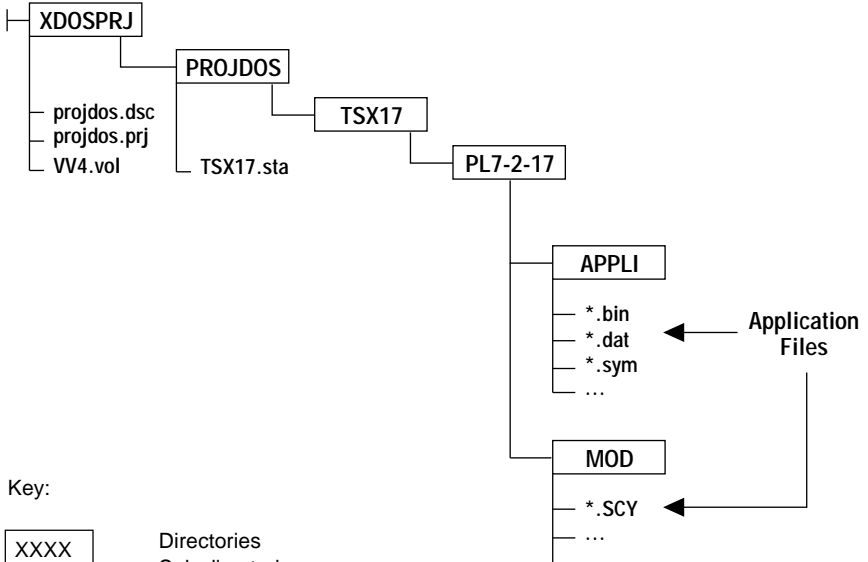

Key:

XXXX Directories
 XXXX Sub-directories

XXXX.XXX Files

The file storage layout of directories and files corresponds to an application developed for a TSX17-20 using PL7-2 language.

7.3 Application Migration from PL7-1/2 V3 to V5

All applications developed with PL7 V3 can, after migration from V3 level to V5 level, be used with PL7 V5 programs. The Import command supports the migration procedure (refer to Sub-section 4.2-9).

7.3-1 V3 Level

The **V3 level tools** use the storage layout shown below:

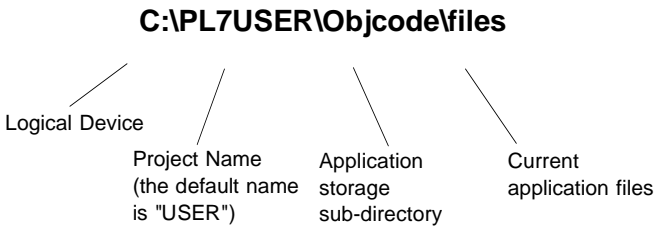

7.3-2 V5 Level

The **V5 level tools** use the storage layout shown below (for the work field):

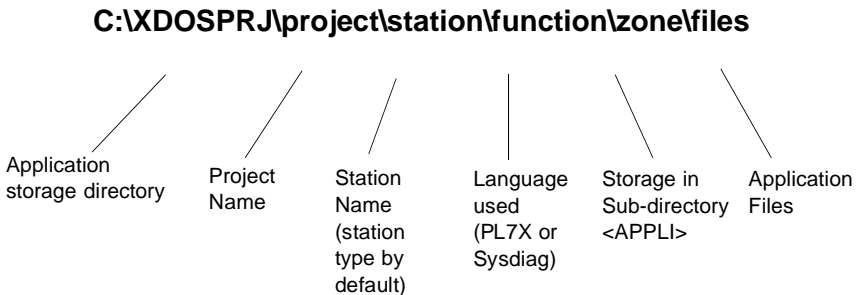

Call-up the on-line help to refer to the storage layout equivalents for each program.

7.4 PL7-2 Application Migration in the Software Workshop

File migration can also be performed from the X-TEL or MINI X-TEL Software Workshops to the User Interface environment or vice-versa.

The Import/Export functions are used to exchange applications between these environments.

Precautions:



- Before making a transfer, ensure compatibility between the source and target zones.
- Do not transfer PL7-2 applications for TSX 17 PLCs to a TSX 27-47 type station.

7.5 Installing a Utility Program

7.5-1 Purpose

Lets the user run a program installed under DOS from the User Interface environment and automatically return to the User Interface once the task is complete.

7.5-2 Operating Mode

Requirement description

Allow the user to run the EPSILON utility directly in order to access files while remaining in the User Interface operating environment.



Note:

The command file name is "EPSILON.REF".

Setting-up the program and its parameters



Ensure that the required program is present under DOS.
Do not use the DOS SHELL command.

- 1 - Using DOS, access the <XDOSSYS> sub-directory
C:>CD _XDOSSYS
- 2 - Select the <REFERE> sub-directory, and press to confirm.
C:>\XDOSSYS\CD _REFERE
- 3 - Copy the "Standard.TE" file to the EPSILON.REF that will become the definition of the executable program to run.



Note:

Terminology specific to the execution of files in the "User Interface" requires that these files take the **extension** ".REF".

The appropriate command line is:

C:>\XDOSSYS\REFERE\Cop\Standard.TE_EPSILON.REF

- 4 - Run a DOS editor. In this example "EDIT" in DOS 5.0 is used. The operation described below will fill-in the definition "USER BLOCK".

C:\>\XDOSYS\REFERE\Edit EPSILON.REF 

The following screen is displayed:

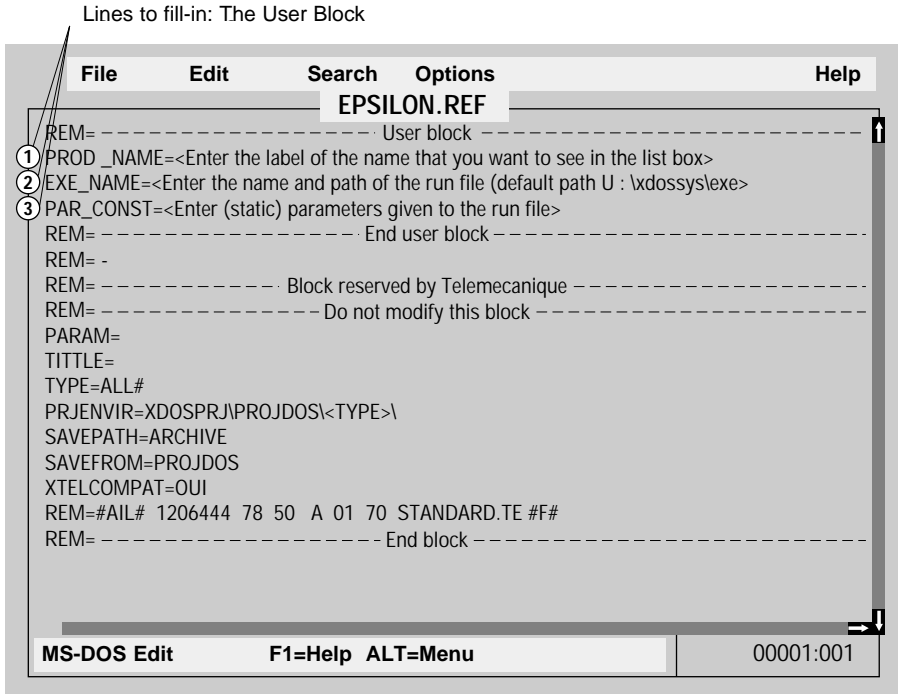

DOS Editor Window

File EPSILON.REF is the result of copying the standard.TE file

Line 1 - Enter the name used to call-up the utility to display in the program list.



Note:

It is possible to install up to 20 programs tools (functions) in this list.

The data entry required is:

Example: PROD_NAME = EPSILON

Line 2 - Define the name and access path for the file to execute (the default path is: C:\xdosys\exe).

C:\ is the prompt designating the logical drive selected when the User Interface was installed.

For the example described above, the entry required is:

EXE_NAME=C:\DOS\EPSILON.EXE

Storage
directory for
EPSILON

Execution
Command

Line 3 - Name of the parameters to assign to the execution file.

For this example the corresponding line will be left blank.

7.5-3 Conclusion

Once the three lines have been filled-in, the user can invoke the TE command and use EPSILON from the User Interface.

7.6 Telemecanique Help

The help screen shown below is displayed when the user presses **F1**

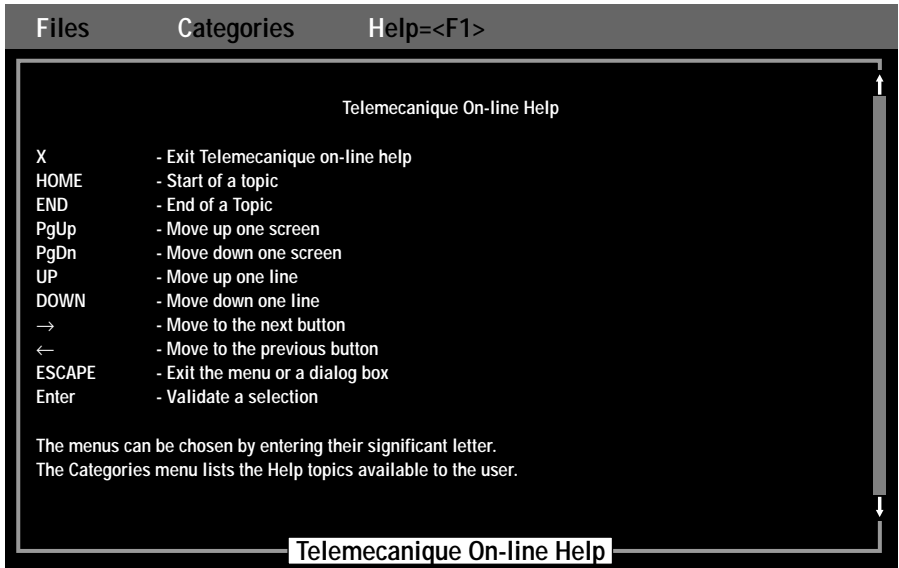

7.7 List of Help Topics

The user can access the help topics via the Categories and List of Screens commands.

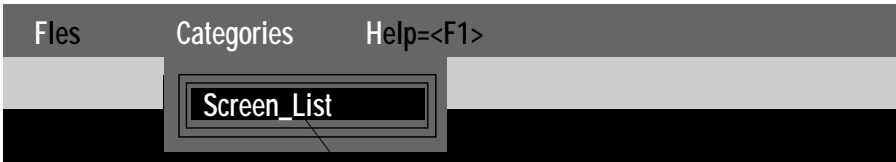

Pressing  to confirm will display the screen shown below:

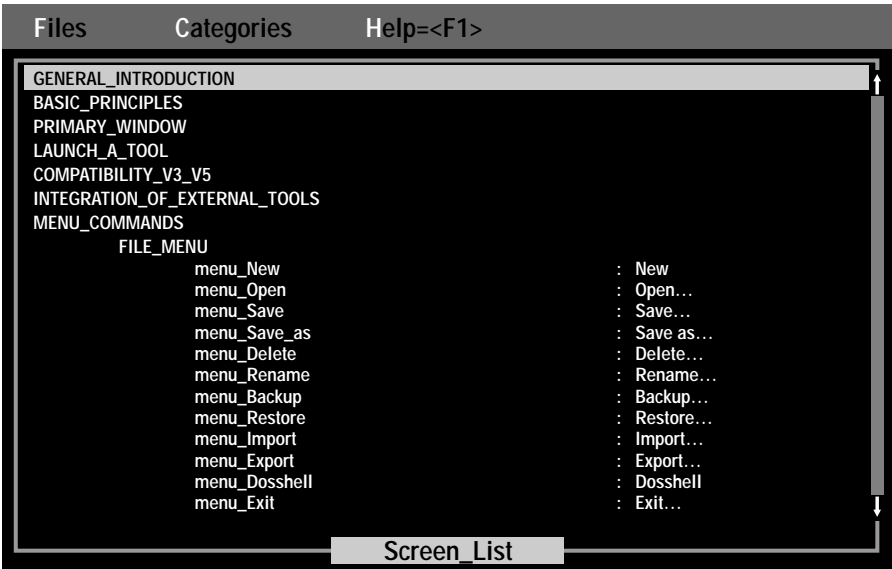

This is a complete list of the help topics available for the User Interface.

7.8 RAM Requirements

For the best system performance with Telemecanique programs, approx. 570 - 580 Kbytes of memory is required. Using the MEM command supported by DOS, check the amount of memory available in your terminal.

If this is inadequate, make any necessary changes to the CONFIG.SYS file (such as deleting unused drivers, etc.).

Reminder:

On FTX 417-20 terminals, the HIDOS.SYS utility loads the operating system kernel in high memory, releasing some of the conventional memory located below the 640 Kbyte boundary.

Typical CONFIG.SYS file for FTX417-20:

```
SHELL=C:\DRDOS\COMMAND.COM /P
BUFFER=10
FILES=10
LASTDRIVE=Z
COUNTRY=033,437, C:\DRDOS\COUNTRY.SYS
DEVICE=C:\DRDOS\VDISK.SYS 1024 512 32/E
DEVICE=C:\DRDOS\HIDOS.SYS /B=FFFF
DEVICE=C:\TE_TOOLS\SCATEMM.SYS
DEVICE=C:\XDOSSYS\EXE\DTSXPC.EXE INST=1 PORT=COM2 CONN=-1
MAXSPEED=19200 TELEMECANIQUE
```

The "FILES" and "BUFFER" **values** can be **increased** if there is enough **memory available** in order to **improve conditions of use** for PL7-2.

7.9 Installing a PL7-3 V3 Program

7.9-1 Introduction

Installing a V3 level program after installing the User Interface should be avoided. Any installation of V3 level software will cause the loss of the updated AUTOEXEC.BAT and CONFIG.SYS files and therefore the data required to start and run the User Interface.

If this cannot be avoided, always reinstall the User Interface.

Never install a program tool from the DOS Shell accessed via the User Interface.

7.9-2 Installing PL7-3 Under DOS

Follow the standard PL7-3 V3 installation procedure, then install the User Interface. Use XDOSSYS\REFERE to edit the PL73 V3.REF file and modify the line PAR_CONST= by replacing the variable "Vdu" with the letter corresponding to the virtual drive unit used by PL7-3:

```
PROD_NAME=PL7-3 V3
EXE  NAME=C:\TE_AP\PL7_3\PL73.COM
PARAM=
PAR_CONST=C Vdu COM2 Bin ← Vdu to fill-in after installing the
TITTLE=                               User Interface
TYPE=TSXV3
PRJENVIR=XDOSPRJ\PROJDOS\TSXV3\PL7_3\APPLI
SAVEPATH=ARCHIVE
SAVEFROM=PROJDOS
XTELCOMPAT=YES
```

7.10 Glossary

The terminology used in this manual comprises:

- **Work field:** Field on the terminal's logical disk drive that is used for the current application.
- **Archive field:** A terminal disk or diskette field. When an application is saved, the user determines which volume will be used (disk or diskette).
- **Project:** A single PLC automation application that is stored in the PROJDOS directory.
An 8 character name is assigned to the project.
- **Station:** A device recognized by the User Interface. By default it corresponds to the type of PLC.
- **Tool:** An element that provides a service for Telemecanique products. A tool can be a program (programming tool) such as PL7-2 or a Telemecanique utility such as the PROM PROGRAMMER or a third party utility program such as the EPSILON editor used in the examples.

7.11 Forcing User Interface Parameters

A change of parameters, where necessary can be made as follows:

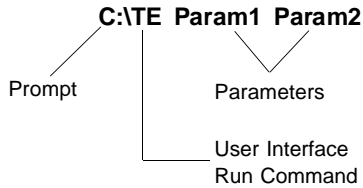

The parameter types are listed below:

Param(x):

Color	→	Forces color video
BW	→	Forces black and white video
COMx with x = 1 or 2	→	Changes the communication port (for V3 level programs)
NoBeep	→	No Beep (for V3 level programs)
UART	→	Changes the speed of data exchanges with the PLC (for V3 level programs).